

# CURVA & GLASS GREAT EFFECT

Una proposta che interpreta un nuovo desiderio di semplicità con un'estetica discreta.

*A proposal that interprets a new simplicity desire with discreet aesthetics.*

Une proposition qui interprète un nouveau désir de simplicité à l'esthétique discrète.













## ANTE SCORREVOLI

Sliding doors • Portes coulissantes • Puertas correderas • РАЗДВИЖНЫЕ СТВОРКИ

### CURVA

Pag. 90

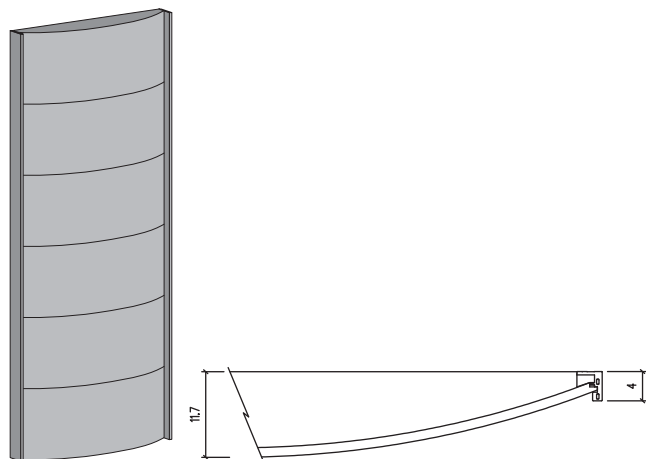

#### Finiture

Finishes • Finitions • Acabados • Отделка

- FB • Frassino bianco • White ash
- FW • Frassino wengè • wenge' ash
- FL • Frassino laccato cartella colori • Lacquered ash as per colour chart

#### Dimensioni ante

Doors dimensions • Dimensions portes • Dimensiones puertas • Размеры створок

H. 231,1 - L. 93,5  
H. 250,3 - L. 93,5

#### Maniglie

Handles • Poignées • Tiradores • РУЧКИ

**2 profili laterali Dx e Sx in finitura ante**  
2 sides profiles right and left in door finish  
2 profils latéraux dr./ga. assortis à la finition des portes  
2 perfiles laterales dcha y izq en acabado de la puerta  
2 боковых профиля, пв и лв, в отделке створки

€	FB	FW	FL			
H.231,1 - H.250,3 - L.93,5	<b>1.239</b>	<b>1.300</b>	<b>1.356</b>			

### DUO

Pag. 92

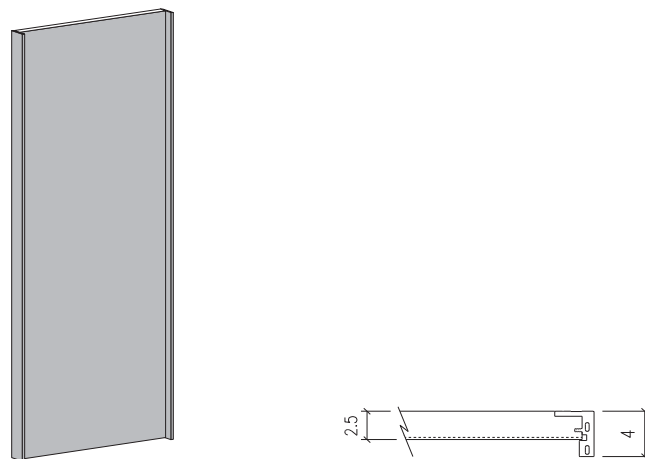

#### Finiture

Finishes • Finitions • Acabados • Отделка

- FB • Frassino bianco • White ash
- NO • Laccato Neve opaco • Matt lacquered neve
- NL • Neve lucido • Neve glass
- FL • Frassino laccato cartella colori • Lacquered ash as per colour chart
- LO • Laccato opaco cartella colori • Matt lacquered as per colour chart
- LL • Laccato lucido cartella colori • Gloss lacquered as per colour chart

#### Dimensioni ante

Doors dimensions • Dimensions portes • Dimensiones puertas • Размеры створок

H. 231,1 - L. 93,5  
H. 231,1 - L. 116  
H. 250,3 - L. 93,5  
H. 250,3 - L. 116

#### Maniglie





Handles • Poignées • Tiradores • РУЧКИ

**2 profili laterali Dx e Sx in finitura ante**  
2 sides profiles right and left in door finish  
2 profils latéraux dr./ga. assortis à la finition des portes  
2 perfiles laterales dcha y izq en acabado de la puerta  
2 боковых профиля, пв и лв, в отделке створки

€	FB	NO	NL	FL	LO	LL
H.231,1 - H.250,3 - L.93,5	<b>658</b>	<b>537</b>	<b>647</b>	<b>813</b>	<b>677</b>	<b>937</b>
H.231,1 - H.250,3 - L.116	<b>780</b>	<b>614</b>	<b>738</b>	<b>940</b>	<b>774</b>	<b>1.157</b>

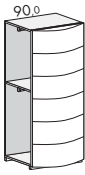
# Moduli anta CURVA

Units with sliding doors • Modules porte coulissante • Modulos puerta corredera • МОДУЛИ С РАЗДВИЖНОЙ СТВОРКОЙ CURVA

Modulo con 1 ripiano e 2 tubi appendiabito unit with 1 shelf and 2 hanging rails module avec 1 tablette et 2 tringles de penderie modulo con 1 estante y 2 barras de colgar Модуль с 1 полкой и 2 трубами-вешалками		Frassino wengè Wengè ash Frêne wengè Fresno wengè Ясень венге	Frassino bianco White ash Frêne blanc Fresno blanco Ясень белый	Frassino laccato cartella colori Lacquered ash as per colour chart Frêne lacqué coloris nuancier Fresno lacado paleta de colores Ясень лак из набора образцов
 <p>90°</p> <p><b>Anta anteriore</b> Front door Porte avant Puerta delantera Передняя створка</p>	H. 234,6	<b>PY3VD141</b> <b>1.482</b>	<b>PY3VE141</b> <b>1.421</b>	<b>PY3VF141</b> <b>1.538</b>
	H. 253,8	<b>PY3VD241</b> <b>1.482</b>	<b>PY3VE241</b> <b>1.421</b>	<b>PY3VF241</b> <b>1.538</b>
 <p>2,5</p> <p>58,9</p> <p><b>Fianco terminale</b> end panel côté de terminaison costado terminal Терминальная боковина</p>	H. 234,6	<b>PYF1D100</b> <b>225</b>	<b>PYF1E100</b> <b>177</b>	<b>PYF1F100</b> <b>225</b>
	H. 253,8	<b>PYF1D200</b> <b>225</b>	<b>PYF1E200</b> <b>177</b>	<b>PYF1F200</b> <b>225</b>
 <p>2,5</p> <p>63,6</p> <p><b>Fianco terminale MAXI</b> end panel MAXI côté de terminaison MAXI costado terminal MAXI Терминальная боковина MAXI</p>	H. 234,6	<b>PYF3D100</b> <b>233</b>	<b>PYF3E100</b> <b>193</b>	<b>PYF3F100</b> <b>245</b>
	H. 253,8	<b>PYF3D200</b> <b>233</b>	<b>PYF3E200</b> <b>193</b>	<b>PYF3F200</b> <b>245</b>
 <p>2,5</p> <p>58,9</p> <p><b>Divisorio</b> partition séparation division Делитель</p>	H. 234,6	<b>PYA41100</b> <b>77</b>		<b>APERTURA CON 2 PROFILI LATERALI IN FINITURA ANTA</b> OPENING WITH 2 SIDE PROFILES WITH THE SAME FINISH AS THE DOOR OUVERTURE AVEC 2 PROFILS LATÉRAUX ASSORTIS À LA PORTE ABERTURA CON 2 PERFILES LATERALES EN ACABADO DE LA PUERTA ОТКРЫВАНИЕ 2 БОКОВЫМИ ПРОФИЛЯМИ С ОТДЕЛКОЙ КАК У СТВОРКИ
	H. 253,8	<b>PYA41200</b> <b>77</b>		



# Armadi anta CURVA+GLASS

Sliding door wardrobes • Armoires à portes coulissantes

Armarios puerta corredera • ШКАФЫ С РАЗДВИЖНОЙ СТВОРКОЙ CURVA + GLASS

CON FIANCHI FIRST IN FINITURA ANTE  
WITH FIRST SIDE PANELS WITH DOOR FINISH  
AVEC CÔTÉ FIRST ASSORTIS AUX PORTES  
CON COSTADOS FIRST EN EL ACABADO DE LAS PUERTAS  
С БОКОВИНАМИ FIRST В ОТДЕЛКЕ СТВОРКИ

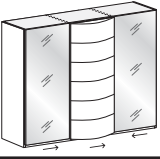
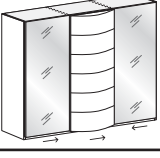
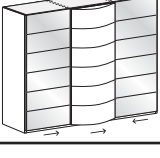
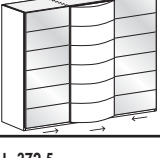
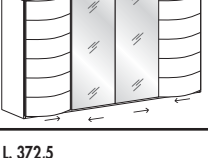
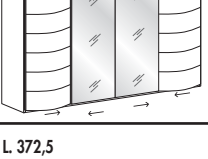
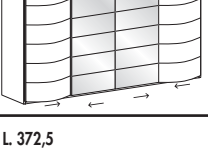
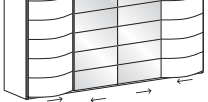
Fianchi in finitura ante SIDE PANELS WITH DOOR FINISH CÔTÉ ASSORTIS AUX PORTES COSTADOS EN EL ACABADO DE LAS PUERTAS БОКОВИНЫ В ОТДЕЛКЕ СТВОРКИ		M <sup>3</sup>	Frassino wengè Wengè ash Frêne wengè Fresno wengè Ясень венге	Frassino bianco White ash Frêne blanc Fresno blanco Ясень белый	Frassino laccato cartella colori Lacquered ash as per colour chart Frêne lacqué coloris nuancier Fresno lacado paleta de colores Ясень лак из набора образцов
L. 280,0 	SPECCHIO MIRROR MIROIR ESPEJO ЗЕРКАЛО	H. 234,6	1,050 PY4V1D13 <b>3.692</b>	PY4V1X13 <b>3.379</b>	PY4V1Y13 <b>3.678</b>
		H. 253,8	1,110 PY4V1D23 <b>3.692</b>	PY4V1X23 <b>3.379</b>	PY4V1Y23 <b>3.678</b>
L. 280,0 	SPECCHIO BRONZO BRONZED MIRROR MIROIR BRONZE ESPEJO BRONCE Зеркало бронза	H. 234,6	1,050 PY4V2D13 <b>3.826</b>	PY4V2X13 <b>3.513</b>	PY4V2Y13 <b>3.812</b>
		H. 253,8	1,110 PY4V2D23 <b>3.826</b>	PY4V2X23 <b>3.513</b>	PY4V2Y23 <b>3.812</b>
L. 280,0 	SPECCHIO BRONZO INCISO ENGRAVED BRONZED MIRROR MIROIR BRONZE GRAVÉ ESPEJO BRONCE GRABADO ЗЕРКАЛО БРОНЗА С ГРАВИРОВКОЙ	H. 234,6	1,050 PY4V3D13 <b>3.894</b>	PY4V3X13 <b>3.581</b>	PY4V3Y13 <b>3.880</b>
		H. 253,8	1,110 PY4V3D23 <b>3.894</b>	PY4V3X23 <b>3.581</b>	PY4V3Y23 <b>3.880</b>
L. 280,0 	SPECCHIO SATINATO INCISO ENGRAVED SATIN MIRROR GLASS MIROIR SATINÉ GRAVÉ ESPEJO SATINADO GRABADO МАТОВОЕ ЗЕРКАЛО С ГРАВИРОВКОЙ	H. 234,6	1,050 PY4V4D13 <b>4.054</b>	PY4V4X13 <b>3.741</b>	PY4V4Y13 <b>4.040</b>
		H. 253,8	1,110 PY4V4D23 <b>4.054</b>	PY4V4X23 <b>3.741</b>	PY4V4Y23 <b>4.040</b>
L. 372,5 	SPECCHIO MIRROR MIROIR ESPEJO ЗЕРКАЛО	H. 234,6	1,530 PY4V1D14 <b>5.267</b>	PY4V1X14 <b>4.901</b>	PY4V1Y14 <b>5.311</b>
		H. 253,8	1,620 PY4V1D24 <b>5.267</b>	PY4V1X24 <b>4.901</b>	PY4V1Y24 <b>5.311</b>
L. 372,5 	SPECCHIO BRONZO BRONZED MIRROR MIROIR BRONZE ESPEJO BRONCE Зеркало бронза	H. 234,6	1,530 PY4V2D14 <b>5.401</b>	PY4V2X14 <b>5.035</b>	PY4V2Y14 <b>5.445</b>
		H. 253,8	1,620 PY4V2D24 <b>5.401</b>	PY4V2X24 <b>5.035</b>	PY4V2Y24 <b>5.445</b>
L. 372,5 	SPECCHIO BRONZO INCISO ENGRAVED BRONZED MIRROR MIROIR BRONZE GRAVÉ ESPEJO BRONCE GRABADO ЗЕРКАЛО БРОНЗА С ГРАВИРОВКОЙ	H. 234,6	1,530 PY4V3D14 <b>5.469</b>	PY4V3X14 <b>5.103</b>	PY4V3Y14 <b>5.513</b>
		H. 253,8	1,620 PY4V3D24 <b>5.469</b>	PY4V3X24 <b>5.103</b>	PY4V3Y24 <b>5.513</b>
L. 372,5 	SPECCHIO SATINATO INCISO ENGRAVED SATIN MIRROR GLASS MIROIR SATINÉ GRAVÉ ESPEJO SATINADO GRABADO МАТОВОЕ ЗЕРКАЛО С ГРАВИРОВКОЙ	H. 234,6	1,530 PY4V4D14 <b>5.629</b>	PY4V4X14 <b>5.263</b>	PY4V4Y14 <b>5.673</b>
		H. 253,8	1,620 PY4V4D24 <b>5.629</b>	PY4V4X24 <b>5.263</b>	PY4V4Y24 <b>5.673</b>

Armadi SCOREVOLI  
Sliding door wardrobes