

SYMPHONIA & DUO

RHYTHMIC MOVEMENTS



La cornice lavorata con il decoro Symphonia impreziosisce e caratterizza, in modo unico, l'anta dell'armadio.

The frame with Symphonia decoration enhances and characterizes in a unique way, the closet door.

Le cadre avec decorum Symphonia embellit la porte de l'armoire.







ANTE BATTENTI

Hinged doors • Portes battantes • Puertas batientes • РАСПАШНЫЕ СТВОРКИ

SMART

Pag. 48

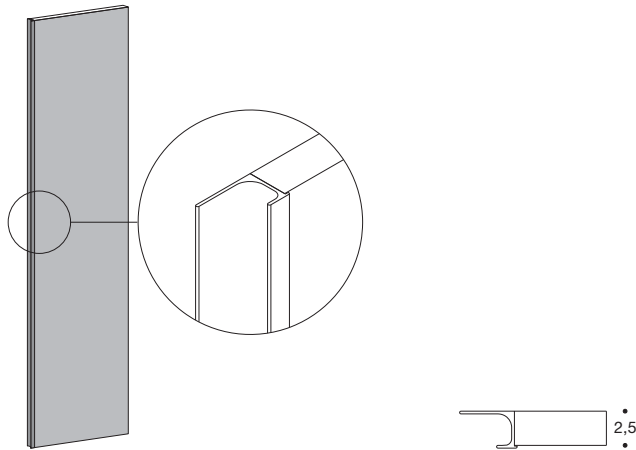

Finitura interna

Interior finish • Finition intérieure • Acabado interno • Внутренняя отделка

Texture • Texture • Texture • Texture • Texture
Olmo • Elm • Orme • Olmo • Вяз

Finiture

Finishes • Finitions • Acabados • Отделку

FB • Frassino bianco • White ash
NO • Laccato Neve opaco • Matt lacquered neve
NL • Neve lucido • Neve gloss
FL • Frassino laccato cartella colori • Lacquered ash as per colour chart
LO • Laccato opaco cartella colori • Matt lacquered as per colour chart
LL • Laccato lucido cartella colori • Gloss lacquered as per colour chart

Dimensioni ante

Doors dimensions • Dimensions portes • Dimensiones puertas • Размеры створок

H. 231,1 - (L. 45,8) + L. 45,8
 H. 231,1 - (L. 57) + L. 57
 H. 250,3 - (L. 45,8) + L. 45,8
 H. 250,3 - (L. 57) + L. 57

Finiture profilo

frame finishes • Finition profil • acabado perfiles • Отделку профиля

Laccato opaco cartella colori • Matt lacquered as per colour chart • Lacqué mat coloris nuancier
 • Laccado mate paleta de colores • Лак матовый из набора образцов
Laccato lucido cartella colori • Gloss lacquered as per colour chart • Lacqué brillant coloris nuancier
 • Laccado brillo paleta de colores • Лак глянцевый из набора образцов

€	FB	NO	NL	FL	LO	LL
H.231,1 - H.250,3 - L.45,8	266	237	261	307	284	346
H.231,1 - H.250,3 - L.57	308	265	316	348	314	382

SYMPHONIA

Pag. 52

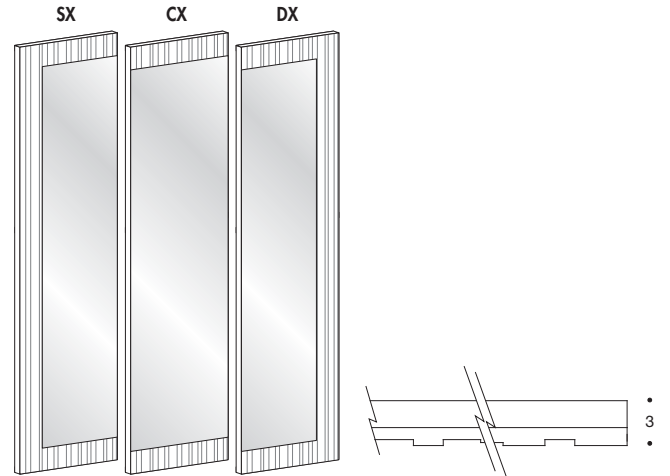

Finitura interna

Interior finish • Finition intérieure • Acabado interno • Внутренняя отделка

Texture • Texture • Texture • Texture • Texture
Olmo • Elm • Orme • Olmo • Вяз

Finiture

Finishes • Finitions • Acabados • Отделку

FB • Frassino bianco • White ash
FW • Frassino wengè • wenge' ash
FL • Frassino laccato cartella colori • Lacquered ash as per colour chart
SB • Specchio bronzo • bronzed mirror

Dimensioni ante

Doors dimensions • Dimensions portes • Dimensiones puertas • Размеры створок

H. 231,1 - L. 57
 H. 250,3 - L. 57

Maniglie

Handles • Poignées • Tiradores • РУЧКИ

Line - Basic

€	FB - sx	FB - dx	FB - cx	FL - sx	FL - dx	FL - cx
H.231,1 - H.250,3 - L.57	590	590	439	590	590	439
€	FW - sx	FW - dx	FW - cx			
H.231,1 - H.250,3 - L.57	590	590	439			

ANTE SCORREVOLI

Sliding doors • Portes coulissantes • Puertas correderas • РАЗДВИЖНЫЕ СТВОРКИ

STAR

Pag. 136

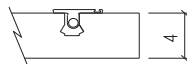
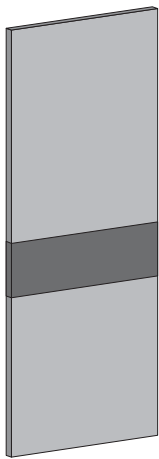

Finiture

Finishes • Finitions • Acabados • Отделка

FB • Frassino bianco • White ash
 NO • Laccato Neve opaco • Matt lacquered neve
 NL • Neve lucido • Neve gloss
 FL • Frassino laccato cartella colori • Lacquered ash as per colour chart
 LO • Laccato opaco cartella colori • Matt lacquered as per colour chart
 LL • Laccato lucido cartella colori • Gloss lacquered as per colour chart

Traverso

trim • Bandeau • travesano • Поперечина

Frassino bianco • White ash
 Frassino carbone • carbone ash
 Frassino wengè • wenge' ash
 Frassino laccato cartella colori • Lacquered ash as per colour chart

Dimensioni ante

Doors dimensions • Dimensions portes • Dimensiones puertas • Размеры створок

H. 231,1 - L. 93,5
 H. 231,1 - L. 116
 H. 231,1 - L. 146
 H. 250,3 - L. 93,5
 H. 250,3 - L. 116
 H. 250,3 - L. 146

Maniglie

Handles • Poignées • Tiradores • РУЧКИ

Easy

	€	FB	NO	NL	FL	LO	LL
H.231,1 - H.250,3 - L.93,5	802	718	747	943	877	1.101	
H.231,1 - H.250,3 - L.116	969	841	869	1.114	1.019	1.308	
H.231,1 - H.250,3 - L.146	1.107	979	954	1.327	1.198	1.313	

SYMPHONIA

Pag. 142

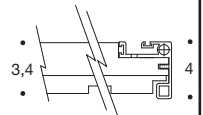
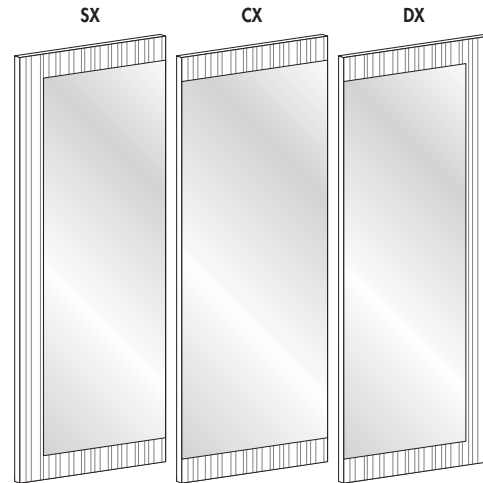

Finiture

Finishes • Finitions • Acabados • Отделка

FB • Frassino bianco • White ash
 FL • Frassino laccato cartella colori • Lacquered ash as per colour chart
 FW • Frassino wengè • wenge' ash

SB • Specchio bronzo • bronzed mirror

Dimensioni ante

Doors dimensions • Dimensions portes • Dimensiones puertas • Размеры створок

H. 231,1 - L. 93,5
 H. 250,3 - L. 93,5

Maniglie

Handles • Poignées • Tiradores • РУЧКИ







2 profili laterali Dx e Sx
 2 sides profiles right and left
 2 profils latéraux D et G
 2 perfiles laterals dcha y izq
 2 боковых профиля ПВ и ЛВ

	€	FB - sx	FB - dx	FB - cx	FL - sx	FL - dx	FL - cx
H.231,1 - H.250,3 - L.93,5	950	950	751	950	950	751	
		FW - sx	FW - dx	FW - cx			
H.231,1 - H.250,3 - L.93,5	950	950	751				

Moduli anta SYMPHONIA SPECCHIO BRONZO

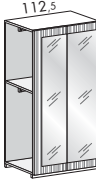

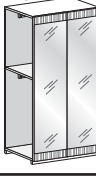

Units with hinged doors SYMPHONIA BRONZED MIRROR • Modules porte battante SYMPHONIA MIROIR BRONZE

Modulos puerta batiente SYMPHONIA ESPEJO BRONCE • МОДУЛИ С РАСПАШНОЙ ДВЕРКОЙ SYMPHONIA ЗЕРКАЛО БРОНЗА

Modulo con 1 ripiano e 2 tubi appendiabito unit with 1 shelf and 2 hanging rails module avec 1 tablette et 2 tringles de penderie modulo con 1 estante y 2 barras de colgar Модуль с 1 полкой и 2 трубами-вешалками		Frassino wengè Wengè ash Frêne wengè Fresno wengè Ясень венге	Frassino bianco White ash Frêne blanc Fresno blanco Ясень белый	Frassino laccato cartella colori Lacquered ash as per colour chart Frêne lacqué coloris nuancier Fresno lacado paleta de colores Ясень лак из набора образцов		
 <p>SX</p>	H. 234,6	PY14D122 753	PY14E122 753	PY14F122 753		
	H. 253,8	PY14D222 753	PY14E222 753	PY14F222 753		
 <p>DX</p>	H. 234,6	PY14D121 753	PY14E121 753	PY14F121 753		
	H. 253,8	PY14D221 753	PY14E221 753	PY14F221 753		
 <p>CX</p>	H. 234,6	PY14D123 602	PY14E123 602	PY14F123 602		
	H. 253,8	PY14D223 602	PY14E223 602	PY14F223 602		
 <p>SX+CX</p>	H. 234,6	PY14D152 1.310	PY14E152 1.310	PY14F152 1.310		
	H. 253,8	PY14D252 1.310	PY14E252 1.310	PY14F252 1.310		
 <p>CX+DX</p>	H. 234,6	PY14D151 1.310	PY14E151 1.310	PY14F151 1.310		
	H. 253,8	PY14D251 1.310	PY14E251 1.310	PY14F251 1.310		
 <p>CX+CX</p>	H. 234,6	PY14D153 1.159	PY14E153 1.159	PY14F153 1.159		
	H. 253,8	PY14D253 1.159	PY14E253 1.159	PY14F253 1.159		
 <p>Fianco terminale end panel côté de terminaison costado terminal Терминальная боковина</p>	H. 234,6	PYF1D100 225	PYF1E100 177	PYF1F100 225		
	H. 253,8	PYF1D200 225	PYF1E200 177	PYF1F200 225		
 <p>Divisorio partition séparation division Делитель</p>	H. 234,6	PYA41100 77				
	H. 253,8	PYA41200 77				

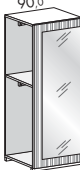
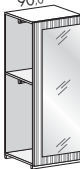
Moduli anta SYMPHONIA

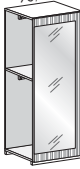
Units with sliding doors • Modules porte coulissante • Modulos puerta corredera • МОДУЛИ С РАЗДВИЖНОЙ СТВОРКОЙ SYMPHONIA

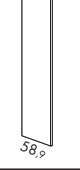
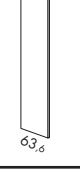
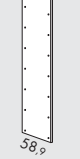
<p>Modulo con 1 ripiano e 2 tubi appendiabito unit with 1 shelf and 2 hanging rails module avec 1 tablette et 2 tringles de penderie modulo con 1 estante y 2 barras de colgar Модуль с 1 полкой и 2 трубами-вешалками</p>	<p>Frassino wengè Wengè ash Frêne wengè Fresno wengè Ясень венге</p>	<p>Frassino bianco White ash Frêne blanc Fresno blanco Ясень белый</p>	<p>Frassino laccato cartella colori Lacquered ash as per colour chart Frêne laccué coloris nuancier Fresno laccado paleta de colores Ясень лак из набора образцов</p>
 <p>SX Anta anteriore Specchio bronzo SX Front door bronzed mirror SX Porte avant miroir bronze SX Puerta delantera espejo bronce SX Передняя створка зеркало бронза</p>	<p>H. 234,6 PY34D142 1.132</p>	<p>PY34E142 1.132</p>	<p>PY34F142 1.132</p>
	<p>H. 253,8 PY34D242 1.132</p>	<p>PY34E242 1.132</p>	<p>PY34F242 1.132</p>
 <p>SX Anta posteriore Specchio bronzo SX Rear door bronzed mirror SX Porte arrière miroir bronze SX Puerta trasera espejo bronce SX Задняя створка зеркало бронза</p>	<p>H. 234,6 PY34D144 1.132</p>	<p>PY34E144 1.132</p>	<p>PY34F144 1.132</p>
	<p>H. 253,8 PY34D244 1.132</p>	<p>PY34E244 1.132</p>	<p>PY34F244 1.132</p>
 <p>DX Anta anteriore Specchio bronzo DX Front door bronzed mirror DX Porte avant miroir bronze DX Puerta delantera espejo bronce DX Передняя створка зеркало бронза</p>	<p>H. 234,6 PY34D141 1.132</p>	<p>PY34E141 1.132</p>	<p>PY34F141 1.132</p>
	<p>H. 253,8 PY34D241 1.132</p>	<p>PY34E241 1.132</p>	<p>PY34F241 1.132</p>
 <p>DX Anta posteriore Specchio bronzo DX Rear door bronzed mirror DX Porte arrière miroir bronze DX Puerta trasera espejo bronce DX Задняя створка зеркало бронза</p>	<p>H. 234,6 PY34D143 1.132</p>	<p>PY34E143 1.132</p>	<p>PY34F143 1.132</p>
	<p>H. 253,8 PY34D243 1.132</p>	<p>PY34E243 1.132</p>	<p>PY34F243 1.132</p>
 <p>CX Anta anteriore Specchio bronzo CX Front door bronzed mirror CX Porte avant miroir bronze CX Puerta delantera espejo bronce CX Передняя створка зеркало бронза</p>	<p>H. 234,6 PY34D145 933</p>	<p>PY34E145 933</p>	<p>PY34F145 933</p>
	<p>H. 253,8 PY34D245 933</p>	<p>PY34E245 933</p>	<p>PY34F245 933</p>
 <p>RIQUADRO Anta anteriore Specchio bronzo FRAMED Front door bronzed mirror CADRE Porte avant miroir bronze RECUADRO Puerta delantera espejo bronce RIQUADRO Передняя створка зеркало бронза</p>	<p>H. 234,6 PY34D147 1.315</p>	<p>PY34E147 1.315</p>	<p>PY34F147 1.315</p>
	<p>H. 253,8 PY34D247 1.315</p>	<p>PY34E247 1.315</p>	<p>PY34F247 1.315</p>
 <p>Fianco terminale end panel côté de terminaison costado terminal Терминальная боковина</p>	<p>H. 234,6 PYF1D100 225</p>	<p>PYF1E100 177</p>	<p>PYF1F100 225</p>
	<p>H. 253,8 PYF1D200 225</p>	<p>PYF1E200 177</p>	<p>PYF1F200 225</p>
 <p>Fianco terminale MAXI end panel MAXI côté de terminaison MAXI costado terminal MAXI Терминальная боковина MAXI</p>	<p>H. 234,6 PYF3D100 233</p>	<p>PYF3E100 193</p>	<p>PYF3F100 245</p>
	<p>H. 253,8 PYF3D200 233</p>	<p>PYF3E200 193</p>	<p>PYF3F200 245</p>
 <p>Divisorio partition séparation division Делитель</p>	<p>H. 234,6 PYA41100 77</p>	<p>APERTURA CON 2 PROFILI LATERALI IN FINITURA ANTA OPENING WITH 2 SIDE PROFILES WITH THE SAME FINISH AS THE DOOR OUVERTURE AVEC 2 PROFILS LATÉRAUX ASSORTIS À LA PORTE ABERTURA CON 2 PERFILES LATERALES EN ACABADO DE LA PUERTA ОТКРЫВАНИЕ 2 БОКОВЫМИ ПРОФИЛЯМИ С ОТДЕЛКОЙ КАК У СТВОРКИ</p>	
	<p>H. 253,8 PYA41200 77</p>		

Armadi anta SYMPHONIA

Sliding door wardrobes • Armoires à portes coulissantes • Armarios puerta corredera • ШКАФЫ С РАЗДВИЖНОЙ СТВОРКОЙ SYMPHONIA

CON FIANCHI FIRST IN FINITURA ANTE
WITH FIRST SIDE PANELS WITH DOOR FINISH
AVEC CÔTÉ FIRST ASSORTIS AUX PORTES
CON COSTADOS FIRST EN EL ACABADO DE LAS PUERTAS
С БОКОВИНАМИ FIRST В ОТДЕЛКЕ СТВОРКИ

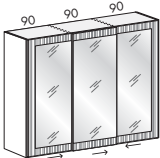
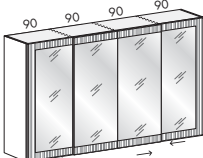
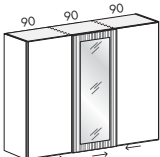
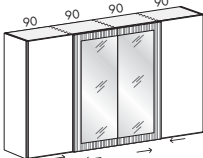
Fianchi in finitura ante SIDE PANELS WITH DOOR FINISH CÔTÉ ASSORTIS AUX PORTES COSTADOS EN EL ACABADO DE LAS PUERTAS БОКОВИНЫ В ОТДЕЛКЕ СТВОРКИ			Frassino wengè Wengè ash Frêne wengè Fresno wengè Ясень венге	Frassino bianco White ash Frêne blanc Fresno blanco Ясень белый	Frassino laccato cartella colori Lacquered ash as per colour chart Frêne laccué coloris nuancier Fresno laccado paleta de colores Ясень лак из набора образцов
L. 187,5 	H. 234,6	0,650	PY44D442 2.799	PY44E442 2.551	PY44F442 2.730
	H. 253,8	0,680	PY44D542 2.799	PY44E542 2.551	PY44F542 2.730
L. 280,0 	H. 234,6	0,905	PY44D443 3.801	PY44E443 3.549	PY44F443 3.731
	H. 253,8	0,950	PY44D543 3.801	PY44E543 3.549	PY44F543 3.731
L. 372,5 	H. 234,6	1,170	PY44D444 4.811	PY44E444 4.559	PY44F444 4.741
	H. 253,8	1,230	PY44D544 4.811	PY44E544 4.559	PY44F544 4.741
L. 280,0  <p>Ante laterali DUO frassino DUO ash lateral doors portes latérales DUO en frêne puertas lateral DUO en fresno Боковые створки DUO ясень</p>	H. 234,6	0,905		PY441X13 3.347	PY441Y13 3.839
	H. 253,8	0,950		PY441X23 3.347	PY441Y23 3.839
L. 372,5  <p>Ante laterali DUO frassino DUO ash lateral doors portes latérales DUO en frêne puertas lateral DUO en fresno Боковые створки DUO ясень</p>	H. 234,6	1,170		PY441X14 4.373	PY441Y14 4.865
	H. 253,8	1,230		PY441X24 4.373	PY441Y24 4.865
APERTURA CON 2 PROFILI LATERALI IN FINITURA ANTE OPENING WITH 2 SIDE PROFILES WITH THE SAME FINISH AS THE DOOR OUVERTURE AVEC 2 PROFILS LATÉRAUX ASSORTIS À LA PORTE ABERTURA CON 2 PERFILES LATERALES EN ACABADO DE LA PUERTA ОТКРЫВАНИЕ 2 БОКОВЫМИ ПРОФИЛЯМИ С ОТДЕЛКОЙ КАК У СТВОРКИ					

Armadi SCOREVOLI
Sliding door wardrobes