

MODULAR

Sistema modulare di contenitori da comporre secondo le esigenze, unisce alla funzionalità e alla praticità d'uso la libertà di creare composizioni uniche. La personalizzazione è resa possibile dalla varietà di scaffali e pensili di diverse misure, dai cassetti con o senza maniglie e dalle quattro tipologie di frontali della collezione living, anche colorati.

Modular system to be composed according to the requirements, it combines the functionality and the freedom to create unique compositions. The customization is made possible by the variety of shelves and cabinets in various sizes, with or without handles from the drawers and the four types of door fronts, whether or not colored.

Système modulaire à composer selon les besoins, il combine la fonctionnalité et la liberté de créer des compositions uniques. La personnalisation est rendue possible par la variété des étagères et des modules en tailles différentes, avec ou sans poignées et des tiroirs et portes dans les quatre types de façade, même colorés.

Благодаря модульной системе, её функциональности и удобства, возможно создавать неповторимые композиции. Персонализация возможна благодаря разнообразию стеллажей и навесных шкафов разных размеров, ящиков с ручкой или без неё, и 4-ём типам фасадов коллекции дневной зоны, даже цветных.







SMAIL MODULAR

Il sistema modulare di contenitori Smail permette di creare composizioni uniche.

Smail modular storage units allows to create unique compositions.

Le système de rangement Smail permet de créer des compositions uniques.

Благодаря модульной системе Smail, возможно создать неповторимые композиции.

























SEQUENCE

MOD01 see on page 13 - 14 - 15 - 17

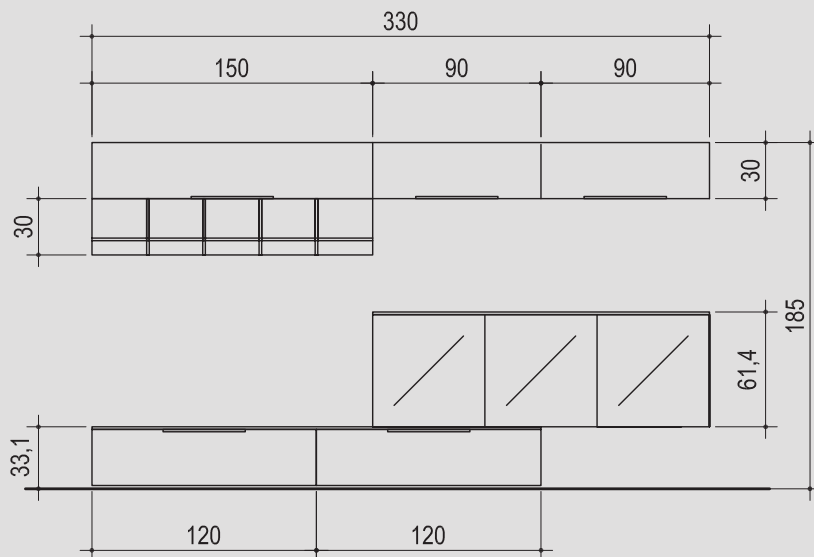

ANTE / DOOR / PORTES / ДВЕРИ

Basic wood grigio
GENESIS Grafite opaco

STRUTTURA / CARCASS / STRUCTURE / СТРУКТУРА
Basic wood grigio

PUNTI / POINTS / POINTS / ТОЧКИ
3331

MOD02 see on page 18

ANTE / DOOR / PORTES / ДВЕРИ

Basic wood moka
LIDO Frassino wengè

STRUTTURA / CARCASS / STRUCTURE / СТРУКТУРА
Basic wood moka

PUNTI / POINTS / POINTS / ТОЧКИ
3838

MOD03 see on page 18 - 19

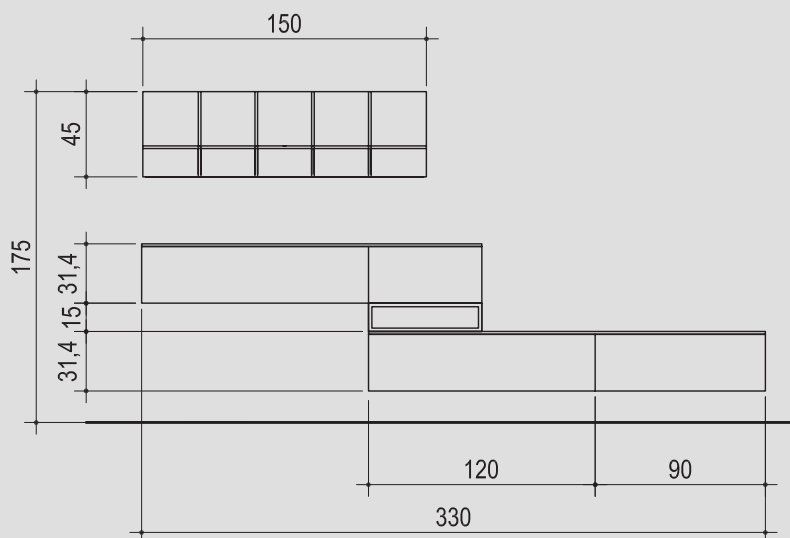

ANTE / DOOR / PORTES / ДВЕРИ

Basic wood avorio
Basic wood grigio

STRUTTURA / CARCASS / STRUCTURE / СТРУКТУРА
Basic wood avorio
Basic wood grigio

PUNTI / POINTS / POINTS / ТОЧКИ
2034

MOD04 see on page 20 - 21

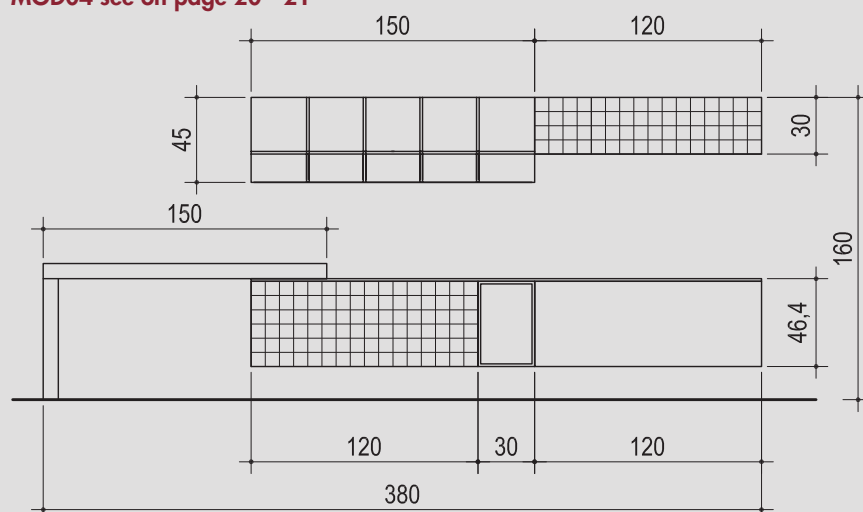

ANTE / DOOR / PORTES / ДВЕРИ

LIDO frassino carbone
Visone opaco

LIBRERIA / BOOKSHELF / BIBLIOTHÈQUE / КНИЖНЫЙ ШКАФ
Tortora scuro

STRUTTURA / CARCASS / STRUCTURE / СТРУКТУРА
Frassino carbone
Visone opaco

PUNTI / POINTS / POINTS / ТОЧКИ
3265

MOD05 see on page 22 - 23

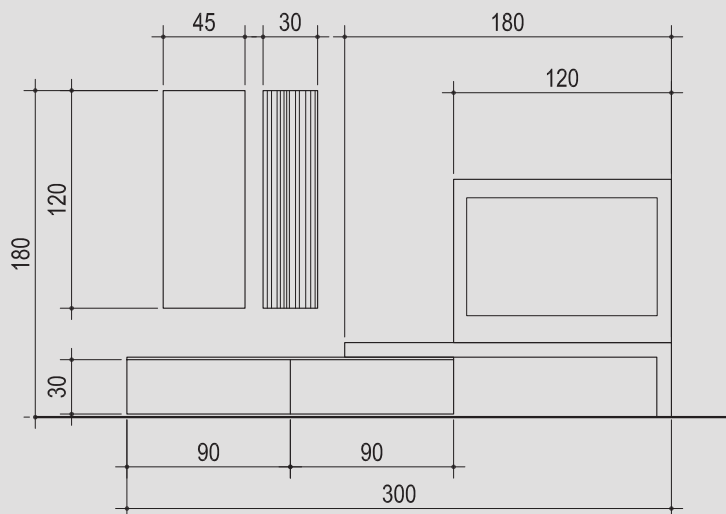

ANTE / DOOR / PORTES / ДВЕРИ
Frassino tortora scuro

PORTA TV / TV-UNIT / PORTE-TV / ТУМБА ДЛЯ ТВ
Frassino tortora scuro

STRUTTURA / CARCASS / STRUCTURE / СТРУКТУРА
Frassino bianco

PUNTI / POINTS / POINTS / ТОЧКИ
2581

MOD06 see on page 24 - 25

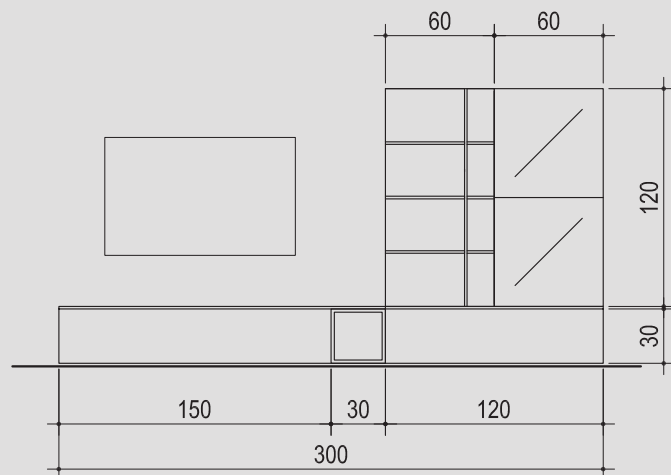

ANTE / DOOR / PORTES / ДВЕРИ
Frassino neve

LIBRERIA / BOOKSHELF / BIBLIOTHÈQUE / КНИЖНЫЙ ШКАФ
Turchese opaco

STRUTTURA / CARCASS / STRUCTURE / СТРУКТУРА
Frassino neve

PUNTI / POINTS / POINTS / ТОЧКИ
2416

MOD07 see on page 26 - 27

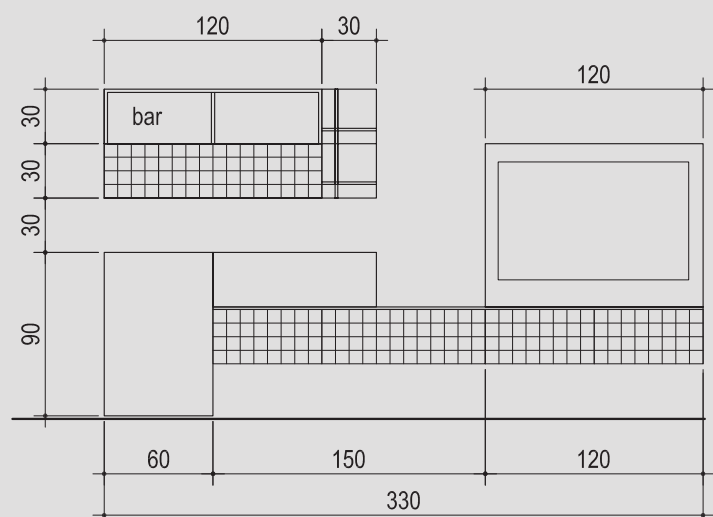

ANTE / DOOR / PORTES / ДВЕРИ
Corda opaco
LIDO frassino polvere

STRUTTURA / CARCASS / STRUCTURE / СТРУКТУРА
Corda opaco

PUNTI / POINTS / POINTS / ТОЧКИ
3814

PERSONALIZE YOUR SMAIL

Personalizzate la vostra composizione | Personnalisez votre composition | Настройте свой состав

MOD08



ANTE / DOOR / PORTES / ДВЕРИ
Smail Liscia

LIBRERIA / BOOKSHELF / BIBLIOTHÈQUE / КНИЖНЫЙ ШКАФ

PUNTI / POINTS / POINTS / ТОЧКИ
2658

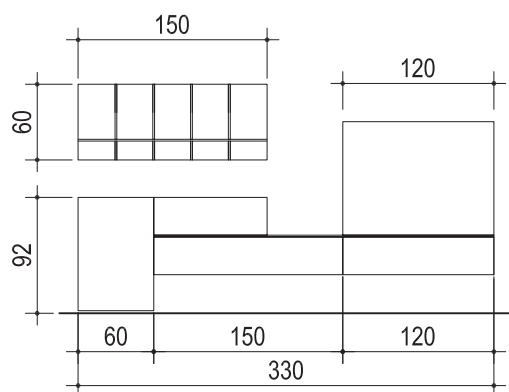

MOD09



ANTE / DOOR / PORTES / ДВЕРИ
Smail Liscia
Lido

PORTA TV / TV-UNIT / PORTE-TV / ТУМБА ДЛЯ ТВ

PUNTI / POINTS / POINTS / ТОЧКИ
2330

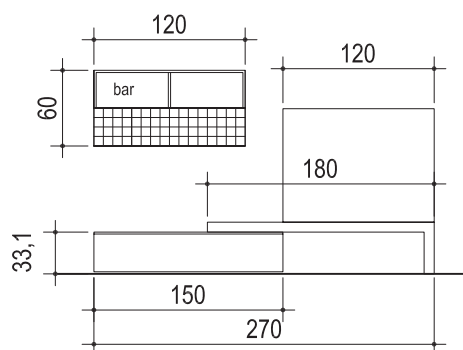

MOD10



ANTE / DOOR / PORTES / ДВЕРИ
Smail Liscia
Basic Wood

LIBRERIA / BOOKSHELF / BIBLIOTHÈQUE / КНИЖНЫЙ ШКАФ

PUNTI / POINTS / POINTS / ТОЧКИ
1613

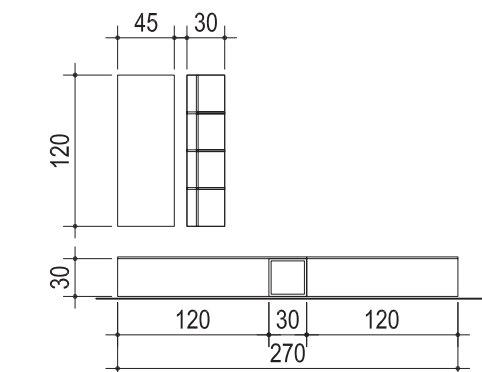

MOD11

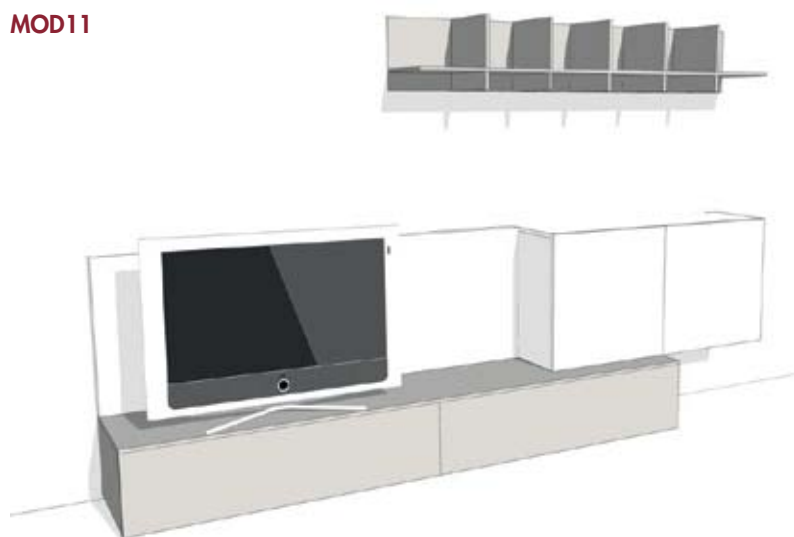

ANTE / DOOR / PORTES / ДВЕРИ
Smail Liscia

LIBRERIA/ BOOKSHELF / BIBLIOTHÈQUE / КНИЖНЫЙ ШКАФ

PUNTI / POINTS / POINTS / ТОЧКИ
2467

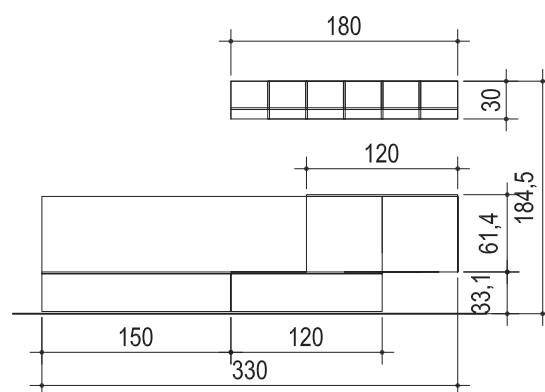

MOD12

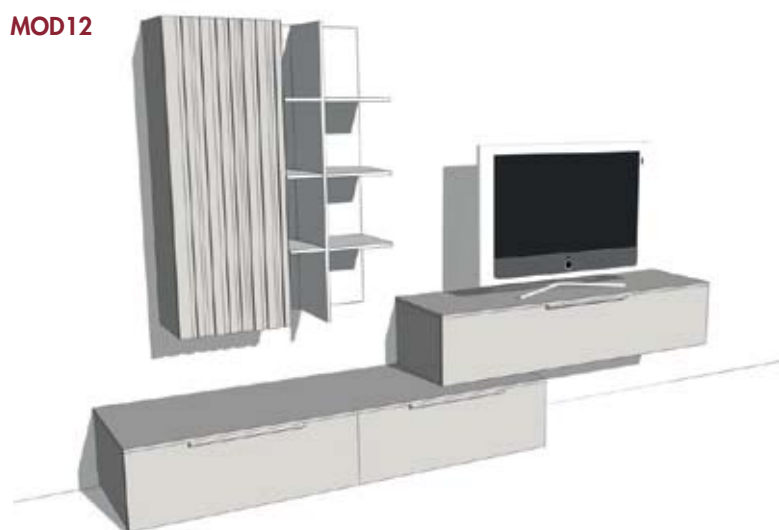

ANTE / DOOR / PORTES / ДВЕРИ
Smail Liscia
Symphonia

LIBRERIA/ BOOKSHELF / BIBLIOTHÈQUE / КНИЖНЫЙ ШКАФ

PUNTI / POINTS / POINTS / ТОЧКИ
2626

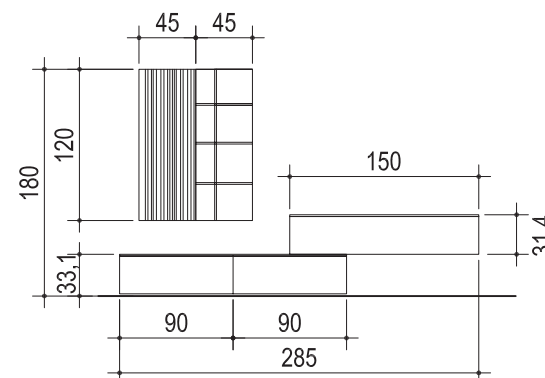

MOD13

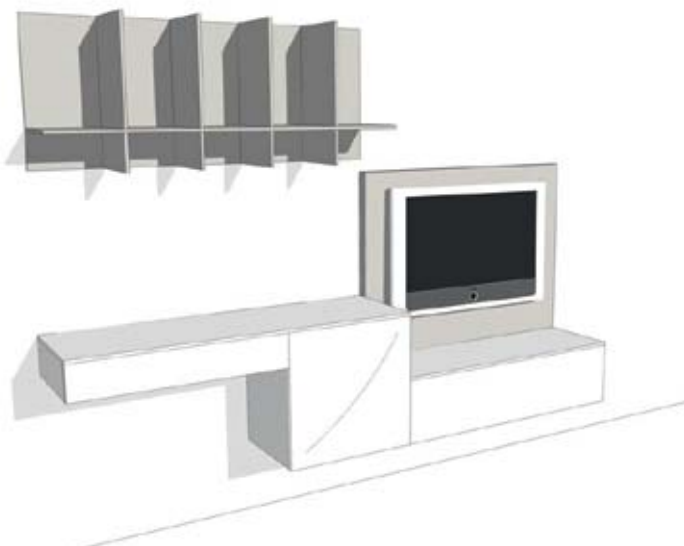

ANTE / DOOR / PORTES / ДВЕРИ
Smail Liscia
Genesis

LIBRERIA/ BOOKSHELF / BIBLIOTHÈQUE / КНИЖНЫЙ ШКАФ

PUNTI / POINTS / POINTS / ТОЧКИ
2154

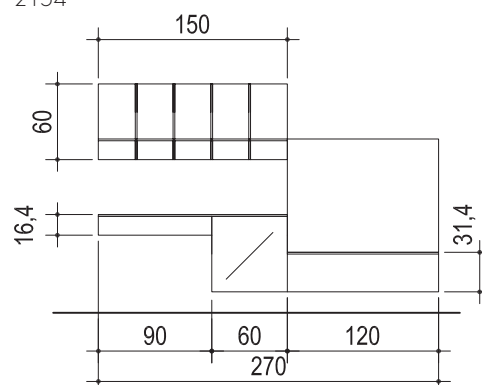

FREE STAN DING

Sistema multifunzionale di contenitori da comporre secondo le esigenze per tenere in ordine gli oggetti della casa e per riporre tutto ciò che non si vuole lasciare in vista. Libertà di personalizzazione con scaffali di diverse misure, cassetti e le quattro tipologie di frontali della collezione living, anche colorati.

Multifunctional storage units to combine each other, according to the requirements in order to keep the objects in the house and put everything that you do not want to leave in sight. Freedom of customization with shelves of different sizes, drawer fronts and the four types of door fronts, whether or not colored. Rangements multifonction à combiner, selon les besoins, afin de garder les objets dans la maison et mettre tout ce que vous ne voulez pas laisser à la vue. Liberté de personnalisation avec des étagères de différentes tailles, façades de tiroirs et portes dans les quatre types de façade, même colorés.

Мультифункциональная система модулей, которые можно составлять по выбору клиента – для поддержания дома в порядке или же для того, что хотят запрятать. Свободный выбор в книжных шкафах разных размеров, ящиков и 4-х типах фасадов коллекции гостиной, даже цветные.







SMAIL FREE STANDING

Gli elementi di Smail permettono di arredare accostando tra loro moduli diversi per forma e funzione così da creare soluzioni assolutamente personalizzate.

The elements of Smail mixed and matched to each other, combine different shapes in order to create completely customized solutions.

Les éléments de Smail mélangés et combinés les uns aux autres, se combinent en formes différentes afin de créer des solutions complètement personnalisées.

Элементы Smail позволяют составлять модули разной формы и функции, таким образом, создавая абсолютно персонализированные решения.

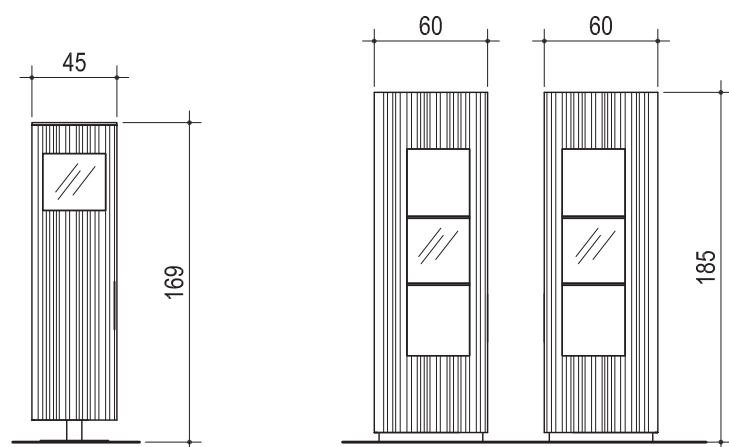





Smail propone per la zona multimediale una serie di soluzioni funzionali: pannelli porta TV con vano passacavi, luce a led indiretta per una migliore visione del video, ampi spazi per contenere consolle digitali e riproduttori di segnale.

Smail proposes various solutions for the home-entertainment area: TV-panel with cable grommets, indirect LED light for better viewing of the video, plenty of space to hold the digital devices and remotes.

Smail propose diverses solutions pour l'espace multimedia: porte-tv avec passe-câbles, l'éclairage LED indirect pour une meilleure visualisation de la vidéo, beaucoup d'espace pour maintenir les appareils numériques et les télécommandes.

Smail предлагает для мультимедийной зоны серию функциональных вариантов: панели для ТВ с отверстием для проводов, непрямая подсветка led для лучшего отображения видео, место для цифрового консоля и передатчика сигнала.



PORTA TV / TV-UNIT / PORTE-TV / ПАНЕЛИ ДЛЯ ТВ
ANTE / DOOR / PORTES / ДВЕРИ
Frassino wengè + Inserto Allegro argento
PUNTI / POINTS / POINTS / ТОЧКИ

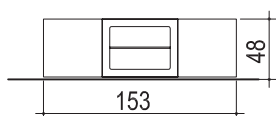

PORTA TV / TV-PANEL / PORTE-TV / ПАНЕЛИ ДЛЯ ТВ
ANTE / DOOR / PORTES / ДВЕРИ
Frassino wengè + Inserto Allegro argento
PUNTI / POINTS / POINTS / ТОЧКИ

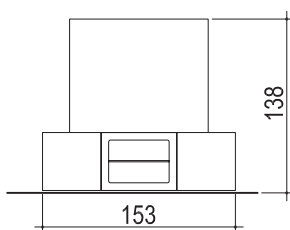

PORTA TV / TV-PANEL / PORTE-TV / ПАНЕЛИ ДЛЯ ТВ
ANTE / DOOR / PORTES / ДВЕРИ
Frassino neve + Inserto Allegro argento
PUNTI / POINTS / POINTS / ТОЧКИ

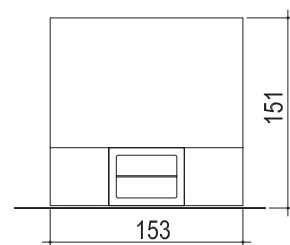



Cast in Order of

Prison Guard	TC
Prison Guard	GE
Joliet Jake	JO
Prison Guard	WA
Corrections Officer	FR
Elwood	DA
Sister Mary Stigma	KA
Curtis	CA
Choirmaster	AL
Beverend Cleophas James	JAL
Choir Soloist	CH
Choir	JAL







SEQUENCE

FRE01 see on page 34 - 35

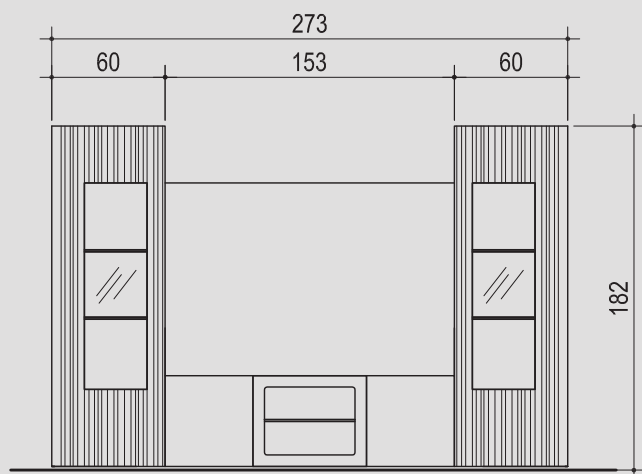

ANTE / DOOR / PORTES / ДВЕРИ
Frassino wengè
SYMPHONIA Frassino wengè
INSERTO / INSERT / INSERT / ВСТАВКА
Allegro argento
STRUTTURA / CARCASS / STRUCTURE / СТРУКТУРА
Frassino wengè
PUNTI / POINTS / POINTS / ТОЧКИ
4777

FRE02 see on page 40 - 41

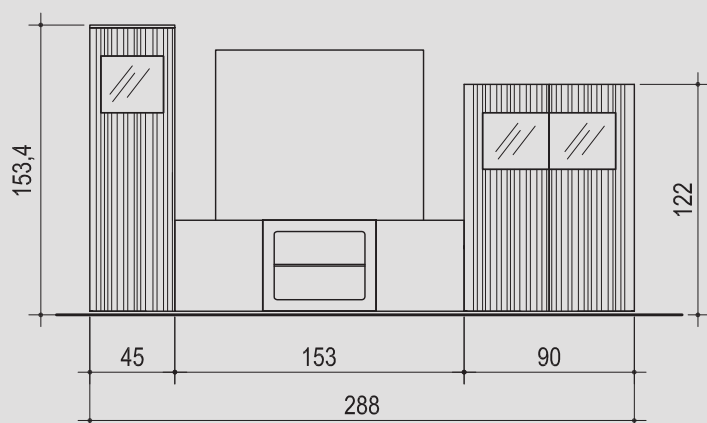

ANTE / DOOR / PORTES / ДВЕРИ
Frassino wengè
SYMPHONIA Frassino wengè
INSERTO / INSERT / INSERT / ВСТАВКА
Allegro argento
STRUTTURA / CARCASS / STRUCTURE / СТРУКТУРА
Frassino wengè
PUNTI / POINTS / POINTS / ТОЧКИ
3892

FRE03 see on page 42 - 43

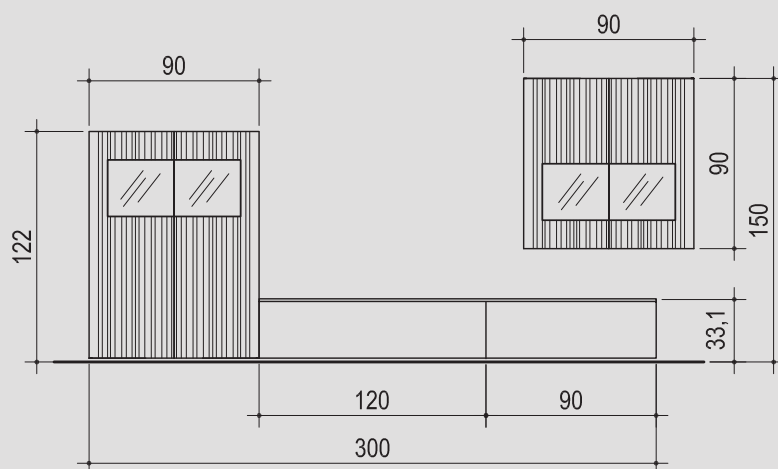

ANTE / DOOR / PORTES / ДВЕРИ
Frassino wengè
SYMPHONIA Frassino wengè
STRUTTURA / CARCASS / STRUCTURE / СТРУКТУРА
Frassino wengè
PUNTI / POINTS / POINTS / ТОЧКИ
3218

PERSONALIZE YOUR SMAIL

Personalizzate la vostra composizione | Personnalisez votre composition | Настройте свой состав

FRE04



ANTE / DOOR / PORTES / ДВЕРИ
Smail Liscia

PUNTI / POINTS / POINTS / ТОЧКИ
1507

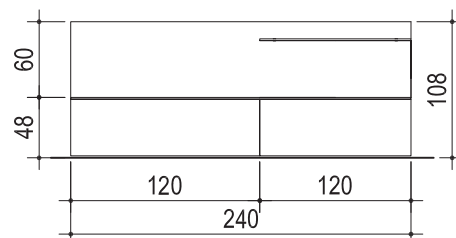

FRE05



ANTE / DOOR / PORTES / ДВЕРИ
Symphonia

PUNTI / POINTS / POINTS / ТОЧКИ
3859

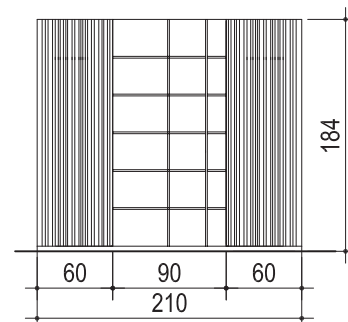

FRE06

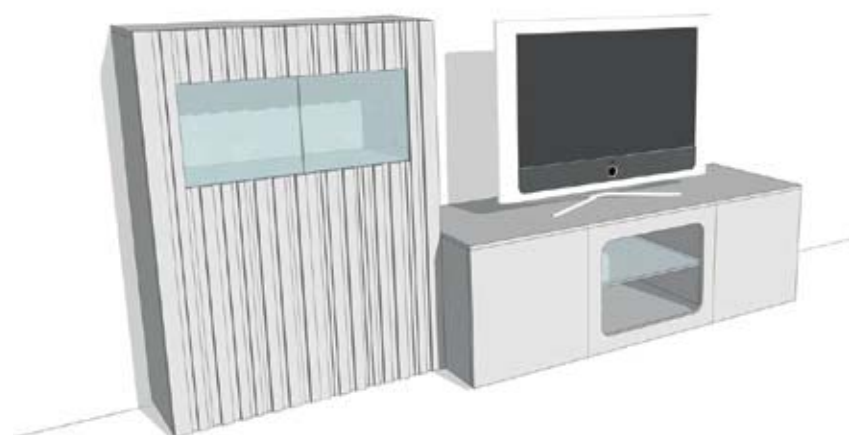

ANTE / DOOR / PORTES / ДВЕРИ
Smail Liscia
Symphonia

PUNTI / POINTS / POINTS / ТОЧКИ
2454

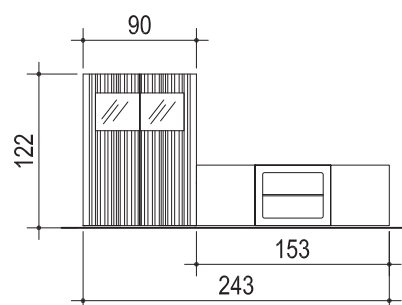

MADIE

Perfette per contenere, le madie sono elementi di arredo elegante e funzionale in ogni stanza. Smail propone un'ampia scelta di colori per creare madie originali e personalizzate.

Perfect to hold, the cupboards are stylish and functional pieces of furniture for every room. Smail offers a wide choice of colors to create original and personalized cupboards.

Idéal pour organiser, les bahuts sont des pièces élégantes et fonctionnelles dans chaque chambre. Smail propose un large choix de couleurs pour créer des bahuts originales et personnalisées.

Тумбы – это элегантные и функциональные элементы мебельной обстановки для каждой комнаты. Smail предлагает большой выбор отделок для создания оригинальных и персонализированных тумб.







SMAIL MADIE



Struttura *Carcass Structure* Структура | FRASSINO CARBONE. Ante *Door Portes* Двери | SMAIL LISCIA + SYMPHONIA FRASSINO CARBONE













È sufficiente scegliere una finitura diversa per trasformare una madia Smail da formale e rigorosa a modaiola e luccicante.

You simply choose a different finish to turn a cupboard Smail from formal and rigorous in fashionable and gleaming.

Il suffit de choisir une finition différente pour transformer une bahut Smail de rigoureuse en à la mode et brillant.

Достаточно выбрать инную отделку для того, чтобы превратить буфет Smail с формального и строгого в модный и блестящий.









La madia cela, al proprio interno, un sofisticato meccanismo che, con un semplice gesto dal telecomando, solleva e rende disponibile un TV a schermo piatto.

The cupboard hides within itself, a sophisticated mechanism that, by the remote control, lift and discover a flat screen TV.

Le bahut cache en lui-même, un mécanisme sophistiqué qui, d'un simple geste de la télécommande, souleve et découvre une télévision à écran plat.

Буфет с потайным отсеком, с изысканным механизмом. Невидимая панель открывается и изнутри поднимается плоский телевизор. Используется пульт дистанционного управления.









In evidenza la particolare lavorazione delle ante con il massello stonato e la strip led che ne disegna la profondità.

Highlights on the special work of the solid wood doors with the additional strip led which draws depth perception.

Détail de la porte arrondie en bois massif et de la bande led qui attire profondeur.

Наяву особенности обработки дверки из скруглённого массива и подсветка strip led, рисующая глубину.



SEQUENCE

see on page 48 - 49

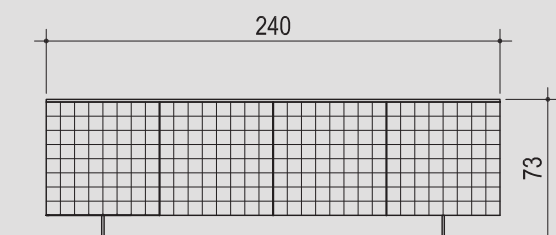

ANTE / DOOR / PORTES / ДВЕРИ
LIDO Frassino carbone

STRUTTURA / CARCASS / STRUCTURE / СТРУКТУРА
Frassino carbone

PUNTI / POINTS / ТОЧКИ
2530

see on page 50

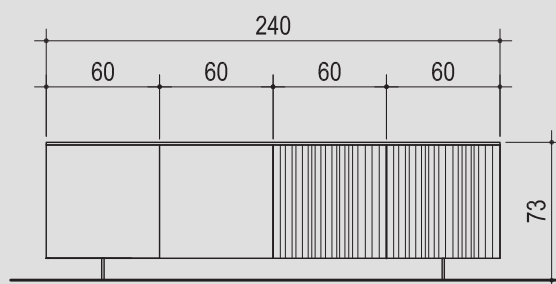

ANTE / DOOR / PORTES / ДВЕРИ
SMALL LISCIA Frassino carbone
SYMPHONIA Frassino carbone

STRUTTURA / CARCASS / STRUCTURE / СТРУКТУРА
Frassino carbone

PUNTI / POINTS / ТОЧКИ
1924

see on page 52 - 53

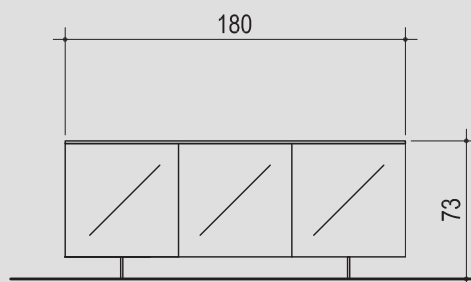

ANTE / DOOR / PORTES / ДВЕРИ
GENESIS Grafite opaco

STRUTTURA / CARCASS / STRUCTURE / СТРУКТУРА
Basic wood grigio

PUNTI / POINTS / ТОЧКИ
1451

see on page 54 - 55

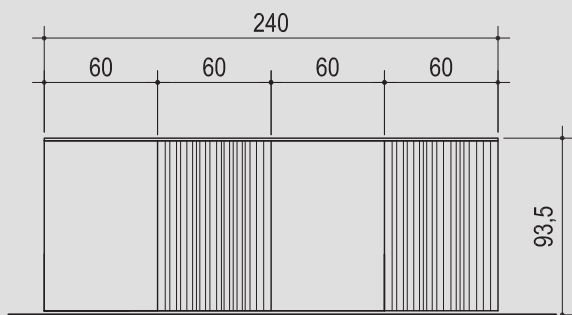

ANTE / DOOR / PORTES / ДВЕРИ
SMAIL LISCIA Frassino bianco
SYMPHONIA Frassino bianco
STRUTTURA / CARCASS / STRUCTURE / СТРУКТУРА
Frassino bianco
PUNTI / POINTS / POINTS / ТОЧКИ
2034

see on page 56

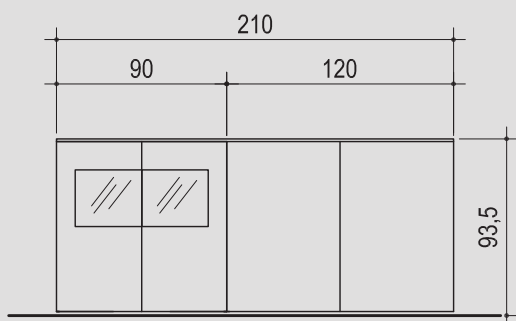

ANTE / DOOR / PORTES / ДВЕРИ
Frassino bianco
INSERTO / INSERT / INSERT / ВСТАВКА
Allegro argento
STRUTTURA / CARCASS / STRUCTURE / СТРУКТУРА
Frassino bianco
PUNTI / POINTS / POINTS / ТОЧКИ
1521

see on page 57 - 61

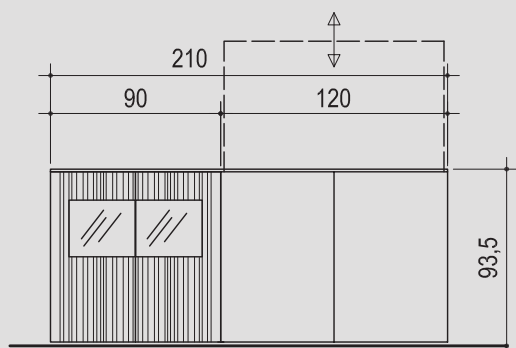

ANTE / DOOR / PORTES / ДВЕРИ
SMAIL LISCIA Frassino wengè
SYMPHONIA Frassino wengè
STRUTTURA / CARCASS / STRUCTURE / СТРУКТУРА
Frassino wengè
PUNTI / POINTS / POINTS / ТОЧКИ
2910

SEQUENCE

see on page 62 - 63

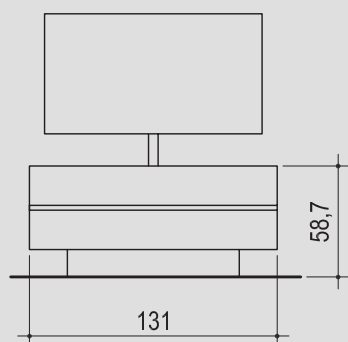

PORTA TV / TV-UNIT / PORTE-TV / ТУМБА ДЛЯ ТВ
DOMINO Turchese opaco

PUNTI / POINTS / POINTS / ТОЧКИ
1866

see on page 64 - 65

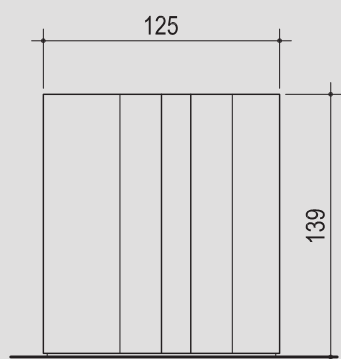

MOBILE BAR / BAR UNIT / ELÉMENT BAR / БАР
ARMONIA Frassino bianco

PUNTI / POINTS / POINTS / ТОЧКИ

1584

PERSONALIZE YOUR SMAIL

Personalizzate la vostra composizione | Personnalisez votre composition | Настройте свой состав

MAD01



ANTE / DOOR / PORTES / ДВЕРИ
Smail Liscia
Lido

PUNTI / POINTS / POINTS / ТОЧКИ
2009

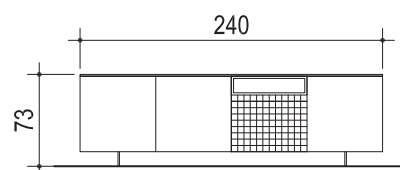

MAD02

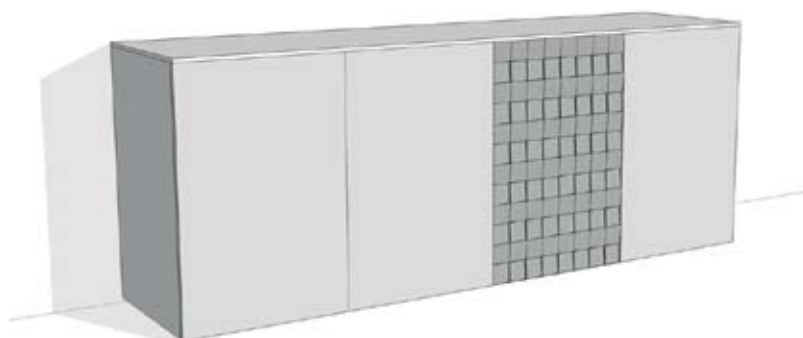

ANTE / DOOR / PORTES / ДВЕРИ
Smail Liscia
Lido

PUNTI / POINTS / POINTS / ТОЧКИ
2053

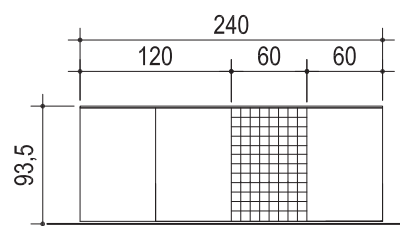

MAD03

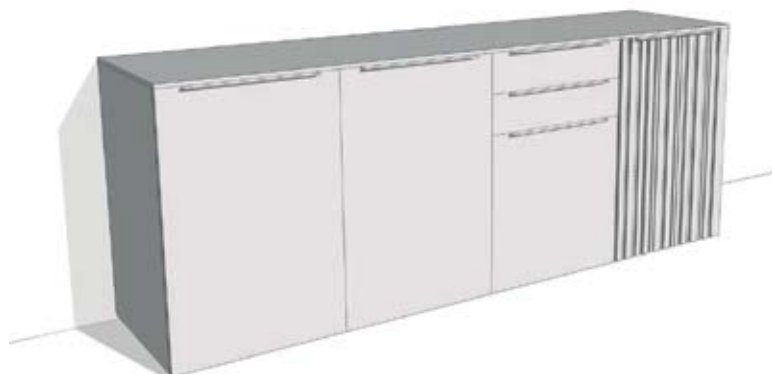

ANTE / DOOR / PORTES / ДВЕРИ
Smail Liscia
Symphonia

PUNTI / POINTS / POINTS / ТОЧКИ
2513

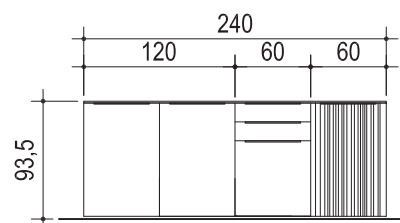

Basi a terra P.57,5

Floor base units D.57,5 • Élément base au sol P.57,5 • Bases de tierra P.57,5 • Напольные основания Г.57,5

Modularità basi a terra

Floor-base modularity • Modularité bases au sol • Modularidad bases de tierra • Модульность напольных оснований

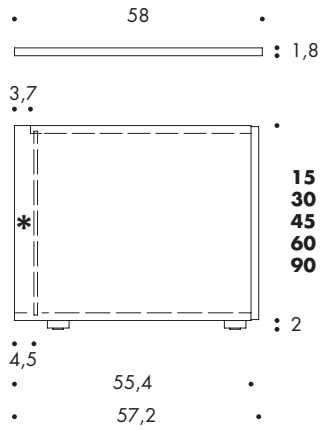
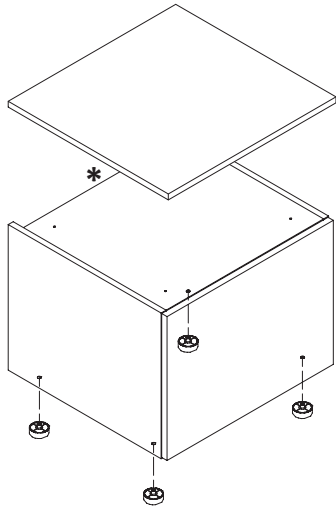

* Vuoto tecnico per passaggio cavi
Empty space for cables
Espace libre pour les câbles
Espacio para cableado
Техническое пространство для прохождения кабеля

Posizione maniglia

Handle position • Position poignée • Posicion del tirador • Расположение ручки

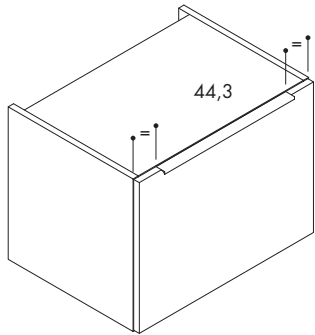

Basi a terra P.57,5

Floor base units D.57,5 • Élément base au sol P.57,5 • Bases de tierra P.57,5 • Напольные основания Г.57,5

Modularità basi a terra

Floor-base modularity • Modularité bases au sol • Modularidad bases de tierra • Модульность напольных оснований

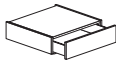
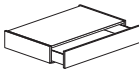
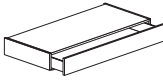
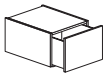
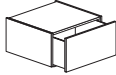
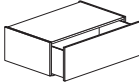
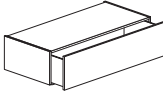
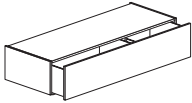
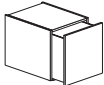
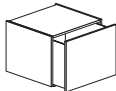
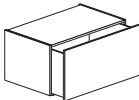
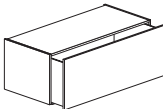
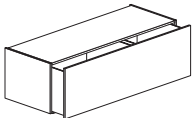
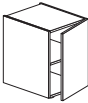
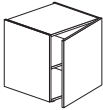
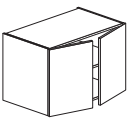
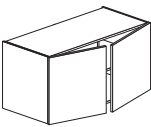
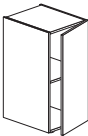
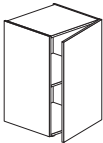
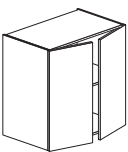
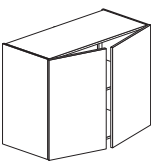
	L. 45	L. 60	L. 90	L. 120	L. 150	
H. 15						
Frontale Front Façade Frente Фасада		SMAIL	SMAIL	SMAIL		
H. 30						
Frontale Front Façade Frente Фасада	SMAIL	SMAIL	SMAIL	SMAIL	SMAIL	
		LIDO	LIDO	LIDO	LIDO	
H. 45						
Frontale Front Façade Frente Фасада	SMAIL	SMAIL	SMAIL	SMAIL	SMAIL	
		LIDO	LIDO	LIDO	LIDO	
H. 60						
Frontale Front Façade Frente Фасада	SMAIL	SMAIL	SMAIL	SMAIL		
		GENESIS		GENESIS		
	LIDO	LIDO	LIDO	LIDO		
	SYMPHONIA	SYMPHONIA	SYMPHONIA	SYMPHONIA		
H. 90						
Frontale Front Façade Frente Фасада	SMAIL	SMAIL	SMAIL	SMAIL		
		LIDO	LIDO	LIDO		
		SYMPHONIA	SYMPHONIA	SYMPHONIA		

Basi a terra H.15 P.57,5 da completare con top di pag. 19

Floor base units H.15 D.57,5 to complete with top of pag. 19 • Élément base au sol H.15 P.57,5 à compléter avec le dessus de la p. 19 • Bases de tierra A.15 p.57,5 para terminar con la encimera de la pag. 19 • Напольные основания В.15Г.57,5 добавить топ со стр. 19

Di serie con apertura PushPull. Con maniglia su frontale + 36 € cad. - Con guide ad estrazione totale + 30 € cad.

Standard with PushPull opening - With handle + 36€ each one - With full extension slides + 30€ each
 Ouverture standard pousse-lâche - Avec poignée +36 € chaque - Avec coulisses pleine extension + 30€ chaque
 De serie con abertura PushPull - Con tirador + 36€ cad. - Con deslizador de extension total + 30€ cad.
 Стандартное открытие PushPull - С ручкой на фасаде + 36 €/шт. - С направляющими полного выдвижения +30 €/шт.

Socca - Carcass - Structure - Estructura - Каркас

Basic wood Basic wood Basic wood Basic wood	Frassino-Laccato opaco Ash wood-Matt lacquered Frêne-laqué mat Madera de fresno-lacado mate Ясень-Лак матовый	Laccato lucido Gloss lacquered Laqué brillant Lacado brillo Лак глянец
--	---	--

L. 60
1 cassetto
1 drawer • 1 tiroir • 1 cajon • 1 ящик

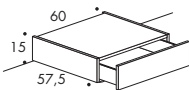

m³ 0,072

Frontale - Front - Façade - Frente - Фасад

	SMAIL	SMB11120	Basic wood Basic wood • Basic wood • Basic wood • Basic wood	206	197	209
			Frassino-Laccato opaco Ash wood-Matt lacquered • Frêne-laqué mat Madera de fresno-lacado mate • Ясень-Лак матовый	219	210	222
			Laccato lucido Gloss lacquered • Laqué brillant • Lacado brillo • Лак глянец	227	218	230

L. 90
1 cassetto
1 drawer • 1 tiroir • 1 cajon • 1 ящик

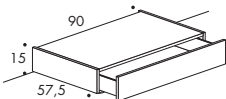

m³ 0,107

Frontale - Front - Façade - Frente - Фасад

	SMAIL	SMB11130	Basic wood Basic wood • Basic wood • Basic wood • Basic wood	233	221	233
			Frassino-Laccato opaco Ash wood-Matt lacquered • Frêne-laqué mat Madera de fresno-lacado mate • Ясень-Лак матовый	251	239	251
			Laccato lucido Gloss lacquered • Laqué brillant • Lacado brillo • Лак глянец	264	252	264

L. 120
1 cassetto
1 drawer • 1 tiroir • 1 cajon • 1 ящик

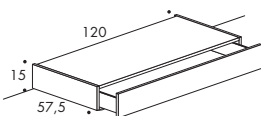

m³ 0,140

Frontale - Front - Façade - Frente - Фасад

	SMAIL	SMB11140	Basic wood Basic wood • Basic wood • Basic wood • Basic wood	278	259	270
			Frassino-Laccato opaco Ash wood-Matt lacquered • Frêne-laqué mat Madera de fresno-lacado mate • Ясень-Лак матовый	303	284	295
			Laccato lucido Gloss lacquered • Laqué brillant • Lacado brillo • Лак глянец	320	301	312

Basi a terra H.30 P.57,5 da completare con top di pag. 19

Floor base units H.30 D.57,5 to complete with top of pag. 19 • Élément base au sol H.30 P.57,5 à compléter avec le dessus de la p. 19 • Bases de tierra A.30 P.57,5 para terminar con la encimera de la pag. 19 • Напольные основания В.30 П.57,5 добавить топ со стр.19

Di serie con apertura PushPull.

Con maniglia su frontale + 36 € cad. - Con guide ad estrazione totale + 30 € cad.

Standard with PushPull opening - With handle + 36€ each one - With full extension slides + 30€ each

Ouverture standard pousse-lâche - Avec poignée +36 € chaque - Avec coulisses pleine extension + 30€ chaque

De serie con apertura PushPull - Con tirador + 36€ cad. - Con deslizadores de extension total + 30€ cad.

Стандартное открывание PushPull - С ручкой на фасаде + 36 €/шт. - С направляющими полного выдвижения +30 €/шт.

Scocca - Carcass - Structure - Estructura - Каркас

Basic wood
Basic wood
Basic wood
Basic wood
Basic wood

Frassino-Laccato opaco
Ash wood-Matt lacquered
Frêne-laqué mat
Madera de fresno-lacado mate
Ясень-Лак матовый

Laccato lucido
Gloss lacquered
Laqué brillant
Lacado brillo
Лак глянец

L. 45

1 cassettone

1 big-drawer • 1 gros tiroir • 1 cajon grande • 1 глубокий ящик

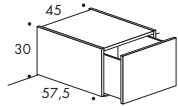

m³ 0,100

Frontale - Front - Façade - Frente - Фасад

	SMAIL	SMB11210	Basic wood Basic wood • Basic wood • Basic wood • Basic wood	222	233	252
			Frassino-Laccato opaco Ash wood-Matt lacquered • Frêne-laqué mat Madera de fresno-lacado mate • Ясень-Лак матовый	240	251	270
			Laccato lucido Gloss lacquered • Laqué brillant • Lacado brillo • Лак глянец	254	265	284

L. 60

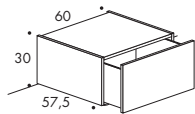

1 cassettone

1 big-drawer • 1 gros tiroir • 1 cajon grande • 1 глубокий ящик



m³ 0,132

Frontale - Front - Façade - Frente - Фасад

	SMAIL	SMB11220	Basic wood Basic wood • Basic wood • Basic wood • Basic wood	237	242	263
			Frassino-Laccato opaco Ash wood-Matt lacquered • Frêne-laqué mat Madera de fresno-lacado mate • Ясень-Лак матовый	262	267	288
			Laccato lucido Gloss lacquered • Laqué brillant • Lacado brillo • Лак глянец	279	284	305
	LIDO	SMB12220	Frassino Ash-wood • Frêne • Madera de fresno • Ясень	402	407	428

L. 90

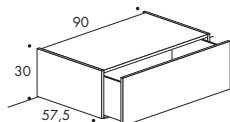

1 cassettone

1 big-drawer • 1 gros tiroir • 1 cajon grande • 1 глубокий ящик



m³ 0,195

Frontale - Front - Façade - Frente - Фасад

	SMAIL	SMB11230	Basic wood Basic wood • Basic wood • Basic wood • Basic wood	269	267	288
			Frassino-Laccato opaco Ash wood-Matt lacquered • Frêne-laqué mat Madera de fresno-lacado mate • Ясень-Лак матовый	305	303	324
			Laccato lucido Gloss lacquered • Laqué brillant • Lacado brillo • Лак глянец	330	328	349
	LIDO	SMB12230	Frassino Ash-wood • Frêne • Madera de fresno • Ясень	507	505	526

Basi a terra H.30 P.57,5 da completare con top di pag. 19

Floor base units H.30 D.57,5 to complete with top of pag. 19 • Élément base au sol H.30 P.57,5 à compléter avec le dessus de la p. 19 • Bases de tierra A.30 P.57,5 para terminar con la encimera de la pag. 19 • Напольные основания В.30 Г.57,5 добавить топ со стр. 19

Di serie con apertura PushPull. Con maniglia su frontale + 36 € cad. - Con guide ad estrazione totale + 30 € cad.

Standard with PushPull opening - With handle + 36€ each one - With full extension slides + 30€ each
 Ouverture standard pousse-lâche - Avec poignée +36 € chaque - Avec coulisses pleine extension + 30€ chaque
 De serie con abertura PushPull - Con tirador + 36€ cad. - Con deslizadores de extension total + 30€ cad.
 Стандартное открытие PushPull - С ручкой на фасаде + 36 €/шт. - С направляющими полного выдвижения +30 €/шт.

Socca - Carcass - Structure - Estructura - Каркас

Basic wood Basic wood Basic wood Basic wood	Frassino-Laccato opaco Ash wood-Matt lacquered Frêne-laqué mat Madera de fresno-lacado mate Ясень-Лак матовый	Laccato lucido Gloss lacquered Laqué brillant Lacado brillo Лак глянец
--	---	--

L. 120

1 cassettone
1 big-drawer • 1 gros tiroir • 1 cajon grande • 1 глубокий ящик

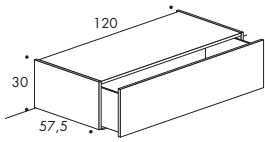

m³ 0,258

Frontale - Front - Façade - Frente - Фасад

	SMAIL	SMB11240	Basic wood Basic wood • Basic wood • Basic wood • Basic wood	319	311	332
			Frassino-Laccato opaco Ash wood-Matt lacquered • Frêne-laqué mat Madera de fresno-lacado mate • Ясень-Лак матовый	370	362	383
			Laccato lucido Gloss lacquered • Laqué brillant • Lacado brillo • Лак глянец	405	397	418
	LIDO	SMB12240	Frassino Ash-wood • Frêne • Madera de fresno • Ясень	622	614	635

L. 150

1 cassettone (internamente diviso 90+60)
1 big-drawer (internally 90+60) • 1 gros tiroir (divisé intérieurement en 90+60) • 1 cajon grande (interior 90+60)
• 1 глубокий ящик (разделён внутри 90+60)

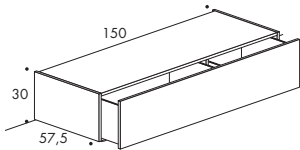

m³ 0,320

Frontale - Front - Façade - Frente - Фасад

	SMAIL	SMB11250	Basic wood Basic wood • Basic wood • Basic wood • Basic wood	427	410	434
			Frassino-Laccato opaco Ash wood-Matt lacquered • Frêne-laqué mat Madera de fresno-lacado mate • Ясень-Лак матовый	489	472	496
			Laccato lucido Gloss lacquered • Laqué brillant • Lacado brillo • Лак глянец	530	513	537
	LIDO	SMB12250	Frassino Ash-wood • Frêne • Madera de fresno • Ясень	763	746	770

Basi a terra H.45 P.57,5 da completare con top di pag. 19

Floor base units H.45 D.57,5 to complete with top of pag. 19 • Élément base au sol H.45 P.57,5 à compléter avec le dessus de la p. 19 • Bases de tierra A.45 P.57,5 para terminar con la encimera de la pag. 19 • Напольные основания В.45 Г.57,5 добавить топ со стр.19

Di serie con apertura PushPull.

Con maniglia su frontale + 36 € cad. - Con guide ad estrazione totale + 30 € cad.

Standard with PushPull opening - With handle + 36€ each one - With full extension slides + 30€ each

Ouverture standard pousse-lâche - Avec poignée +36 € chaque - Avec coulisses pleine extension + 30€ chaque

De serie con apertura PushPull - Con tirador + 36€ cad. - Con deslizador de extension total + 30€ cad.

Стандартное открывание PushPull - С ручкой на фасаде + 36 €/шт. - С направляющими полного выдвижения +30 €/шт.

Scocca - Carcass - Structure - Estructura - Каркас

Basic wood
Basic wood
Basic wood
Basic wood
Basic wood

Frassino-Laccato opaco
Ash wood-Matt lacquered
Frêne-laqué mat
Madera de fresno-lacado mate
Ясень-Лак матовый

Laccato lucido
Gloss lacquered
Laqué brillant
Lacado brillo
Лак глянец

L. 45

1 cassettone

1 big-drawer • 1 gros tiroir • 1 cajon grande • 1 глубокий ящик

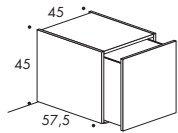

m³ 0,147

Frontale - Front - Façade - Frente - Фасад

	SMAIL	SMB11310	Basic wood Basic wood • Basic wood • Basic wood • Basic wood	233	255	286
			Frassino-Laccato opaco Ash wood-Matt lacquered • Frêne-laqué mat Madera de fresno-lacado mate • Ясень-Лак матовый	260	282	313
			Laccato lucido Gloss lacquered • Laqué brillant • Lacado brillo • Лак глянец	280	302	333

L. 60

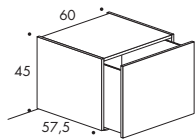

1 cassettone

1 big-drawer • 1 gros tiroir • 1 cajon grande • 1 глубокий ящик



m³ 0,192

Frontale - Front - Façade - Frente - Фасад

	SMAIL	SMB11320	Basic wood Basic wood • Basic wood • Basic wood • Basic wood	252	266	297
			Frassino-Laccato opaco Ash wood-Matt lacquered • Frêne-laqué mat Madera de fresno-lacado mate • Ясень-Лак матовый	290	304	335
			Laccato lucido Gloss lacquered • Laqué brillant • Lacado brillo • Лак глянец	316	330	361
	LIDO	SMB12320	Frassino Ash-wood • Frêne • Madera de fresno • Ясень	498	512	543

L. 90

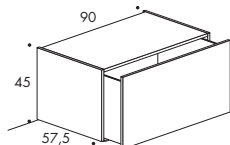

1 cassettone

1 big-drawer • 1 gros tiroir • 1 cajon grande • 1 глубокий ящик



m³ 0,284

Frontale - Front - Façade - Frente - Фасад

	SMAIL	SMB11330	Basic wood Basic wood • Basic wood • Basic wood • Basic wood	286	298	328
			Frassino-Laccato opaco Ash wood-Matt lacquered • Frêne-laqué mat Madera de fresno-lacado mate • Ясень-Лак матовый	343	355	385
			Laccato lucido Gloss lacquered • Laqué brillant • Lacado brillo • Лак глянец	382	394	424
	LIDO	SMB12330	Frassino Ash-wood • Frêne • Madera de fresno • Ясень	620	632	662

Basi a terra H.45 P.57,5 da completare con top di pag. 19

Floor base units H.45 D.57,5 to complete with top of pag. 19 • Élément base au sol H.45 P.57,5 à compléter avec le dessus de la p. 19 • Bases de tierra A.45 P.57,5 para terminar con la encimera de la pag. 19 • Напольные основания B.45 P.57,5 добавить топ со стр. 19

Di serie con apertura PushPull. Con maniglia su frontale + 36 € cad. - Con guide ad estrazione totale + 30 € cad.

Standard with PushPull opening - With handle + 36€ each one - With full extension slides + 30€ each
 Ouverture standard pousse-lâche - Avec poignée +36 € chaque - Avec coulisses pleine extension + 30€ chaque
 De serie con abertura PushPull - Con tirador + 36€ cad. - Con deslizadores de extension total + 30€ cad.
 Стандартное открытие PushPull - С ручкой на фасаде + 36 €/шт. - С направляющими полного выдвижения +30 €/шт.

Socca - Carcass - Structure - Estructura - Каркас

Basic wood Basic wood Basic wood Basic wood Basic wood	Frassino-Laccato opaco Ash wood-Matt lacquered Frêne-laqué mat Madera de fresno-lacado mate Ясень-Лак матовый	Laccato lucido Gloss lacquered Laqué brillant Lacado brillo Лак глянец
--	---	--

L. 120

1 cassettone
1 big-drawer • 1 gros tiroir • 1 cajon grande • 1 глубокий ящик

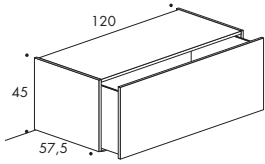

m³ 0,375

Frontale - Front - Façade - Frente - Фасад

	SMAIL	SMB11340	Basic wood Basic wood • Basic wood • Basic wood • Basic wood	342	345	376
			Frassino-Laccato opaco Ash wood-Matt lacquered • Frêne-laqué mat Madera de fresno-lacado mate • Ясень-Лак матовый	418	421	452
			Laccato lucido Gloss lacquered • Laqué brillant • Lacado brillo • Лак глянец	472	475	506
	LIDO	SMB12340	Frassino Ash-wood • Frêne • Madera de fresno • Ясень	777	780	811

L. 150

1 cassettone (internamente diviso 90+60)
1 big-drawer (internally 90+60) • 1 gros tiroir (divisé intérieurement en 90+60) • 1 cajon grande (interior 90+60)
• 1 глубокий ящик (разделён внутри 90+60)

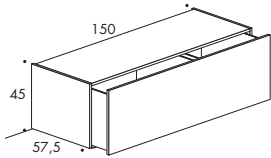

m³ 0,467

Frontale - Front - Façade - Frente - Фасад

	SMAIL	SMB11350	Basic wood Basic wood • Basic wood • Basic wood • Basic wood	453	446	476
			Frassino-Laccato opaco Ash wood-Matt lacquered • Frêne-laqué mat Madera de fresno-lacado mate • Ясень-Лак матовый	547	540	570
			Laccato lucido Gloss lacquered • Laqué brillant • Lacado brillo • Лак глянец	615	608	638
	LIDO	SMB12350	Frassino Ash-wood • Frêne • Madera de fresno • Ясень	974	967	997

Basi a terra H.60 P.57,5 da completare con top di pag. 19

Floor base units H.60 D.57,5 to complete with top of pag. 19 • Élément base au sol H.60 P.57,5 à compléter avec le dessus de la p. 19 • Bases de tierra A.60 P.57,5 para terminar con la encimera de la pag. 19 • Напольные основания В.60 П.57,5 добавить топ со стр.19

Di serie con apertura PushPull. Con maniglia su frontale + 36 € cad.

Standard with PushPull opening - With handle + 36€ each one

Ouverture standard pousse-lâche - Avec poignée +36 € chaque

De serie con abertura PushPull - Con tirador + 36€ cad.

Стандартное открывание PushPull - С ручкой на фасаде + 36 €/шт.

Scocca - Carcass - Structure - Estructura - Каркас

Basic wood
Basic wood
Basic wood
Basic wood
Basic wood

Frassino-Laccato opaco
Ash wood-Matt lacquered
Frêne-laqué mat
Madera de fresno-lacado mate
Ясень-Лак матовый

Laccato lucido
Gloss lacquered
Laqué brillant
Lacado brillo
Лак глянец

L. 45

1 anta, con 1 ripiano legno

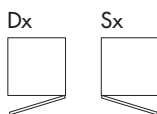
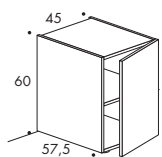

1 door, with 1 wooden shelf • 1 porte avec 1 étagère bois • 1 puerta, con 1 estante de madera

1 дверка, с 1 деревянной полкой

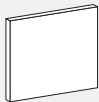
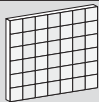

m³ 0,192

Frontale - Front - Façade - Frente - Фасад

	SMAIL	Dx SMB11411	Basic wood Basic wood • Basic wood • Basic wood • Basic wood	251	272	326
		Sx SMB11412	Frassino-Laccato opaco Ash wood-Matt lacquered • Frêne-laqué mat Madera de fresno-lacado mate • Ясень-Лак матовый	288	309	363
	LIDO	Dx SMB12411	Frassino Ash-wood • Frêne • Madera de fresno • Ясень	496	517	571
		Sx SMB12412	Laccato lucido Gloss lacquered • Laqué brillant • Lacado brillo • Лак глянец	314	335	389
	SYMPHONIA	Dx SMB14411	Frassino Ash-wood • Frêne • Madera de fresno • Ясень	424	445	499
		Sx SMB14412				

L. 60

1 anta, con 1 ripiano legno



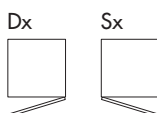
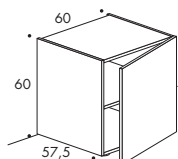

1 door, with 1 wooden shelf • 1 porte avec 1 étagère bois • 1 puerta, con 1 estante de madera

1 дверка, с 1 деревянной полкой

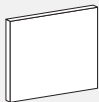

m³ 0,252

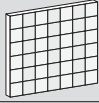
Frontale - Front - Façade - Frente - Фасад

	SMAIL	Dx SMB11421	Basic wood Basic wood • Basic wood • Basic wood • Basic wood	270	289	342
		Sx SMB11422	Frassino-Laccato opaco Ash wood-Matt lacquered • Frêne-laqué mat Madera de fresno-lacado mate • Ясень-Лак матовый	320	339	392
	GENESIS No pushpull No pushpull • No pousse-lâche No pushpull • Не может быть push-pull	Dx SMB13421	Frassino-Laccato opaco Ash wood-matt lacquered • Frêne-laqué mat Madera de fresno-lacado mate • Ясень-Лак матовый	417	436	489
		Sx SMB13422				
	LIDO	Dx SMB12421	Frassino Ash-wood • Frêne • Madera de fresno • Ясень	581	600	653
		Sx SMB12422				
	SYMPHONIA	Dx SMB14421	Frassino Ash-wood • Frêne • Madera de fresno • Ясень	539	558	611
		Sx SMB14422				

Basi a terra H.60 P.57,5 da completare con top di pag. 19

Floor base units H.60 D.57,5 to complete with top of pag. 19 • Élément base au sol H.60 P.57,5 à compléter avec le dessus de la p. 19 • Bases de tierra A.60 P.57,5 para terminar con la encimera de la pag. 19 • Напольные основания В.60 Г.57,5 добавить топ со стр. 19

Di serie con apertura PushPull. Con maniglia su frontale + 36 € cad.

Standard with PushPull opening - With handle + 36€ each one
Ouverture standard pousse-lâche - Avec poignée +36 € chaque
De serie con abertura PushPull - Con tirador + 36€ cad.

Стандартное открывание PushPull - С ручкой на фасаде + 36 €/шт.

Scocca - Carcass - Structure - Estructura - Каркас

Basic wood Basic wood Basic wood Basic wood Basic wood	Frassino-Laccato opaco Ash wood-Matt lacquered Frêne-laqué mat Madera de fresno-lacado mate Ясень-Лак матовый	Laccato lucido Gloss lacquered Laqué brillant Lacado brillo Лак глянец
--	---	--

L. 90

2 ante, con 1 ripiano legno

2 doors, with 1 wooden shelf • 2 portes avec 1 étagère bois • 2 puertas, con 1 estante de madera

2 дверки, с 1 деревянной полкой

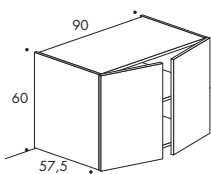

m³ 0,373

Frontale - Front - Façade - Frente - Фасад

	SMAIL	SMB11430	Basic wood Basic wood • Basic wood • Basic wood • Basic wood	355	363	418
			Frassino-Laccato opaco Ash wood-Matt lacquered • Frêne-laqué mat Madera de fresno-lacado mate • Ясень-Лак матовый	429	437	492
			Laccato lucido Gloss lacquered • Laqué brillant • Lacado brillo • Лак глянец	481	489	544
	LIDO	SMB12430	Frassino Ash-wood • Frêne • Madera de fresno • Ясень	845	853	908
	SYMPHONIA	SMB14430	Frassino Ash-wood • Frêne • Madera de fresno • Ясень	701	709	764

L. 120

2 ante, con 1 ripiano legno

2 doors, with 1 wooden shelf • 2 portes avec 1 étagère bois • 2 puertas, con 1 estante de madera

2 дверки, с 1 деревянной полкой

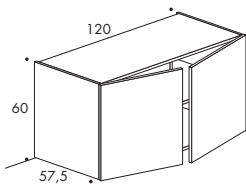

m³ 0,493

Frontale - Front - Façade - Frente - Фасад

	SMAIL	SMB11440	Basic wood Basic wood • Basic wood • Basic wood • Basic wood	412	412	467
			Frassino-Laccato opaco Ash wood-Matt lacquered • Frêne-laqué mat Madera de fresno-lacado mate • Ясень-Лак матовый	512	512	567
			Laccato lucido Gloss lacquered • Laqué brillant • Lacado brillo • Лак глянец	584	584	639
	GENESIS No pushpull No pushpull • No pousse-lâche No pushpull • Не может быть push-pull	SMB13440	Frassino-Laccato opaco Ash wood-matt lacquered • Frêne-laqué mat Madera de fresno-lacado mate • Ясень-Лак матовый	706	706	761
	LIDO	SMB12440	Frassino Ash-wood • Frêne • Madera de fresno • Ясень	1.034	1.034	1.089
	SYMPHONIA	SMB14440	Frassino Ash-wood • Frêne • Madera de fresno • Ясень	950	950	1.005

Basi a terra H.90 P.57,5 da completare con top di pag. 19

Floor base units H.90 D.57,5 to complete with top of pag. 19 • Élément base au sol H.90 P.57,5 à compléter avec le dessus de la p. 19 • Bases de tierra A.90 P.57,5 para terminar con la encimera de la pag. 19 • Напольные основания В.90 П.57,5 добавить топ со стр.19

Di serie con apertura PushPull. Con maniglia su frontale + 36 € cad.

Standard with PushPull opening - With handle + 36€ each one
Ouverture standard pousse-lâche - Avec poignée +36 € chaque
De serie con abertura PushPull - Con tirador + 36€ cad.

Стандартное открывание PushPull - С ручкой на фасаде + 36 €/шт.

Scocca - Carcass - Structure - Estructura - Каркас

Basic wood
Basic wood
Basic wood
Basic wood
Basic wood

Frassino-Laccato opaco
Ash wood-Matt lacquered
Frêne-laqué mat
Madera de fresno-lacado mate
Ясень-Лак матовый

Laccato lucido
Gloss lacquered
Laqué brillant
Lacado brillo
Лак глянец

L. 45

1 anta, con 1 ripiano legno

1 door, with 1 wooden shelf • 1 porte avec 1 étagère bois • 1 puerta, con 1 estante de madera

1 дверка, с 1 деревянной полкой

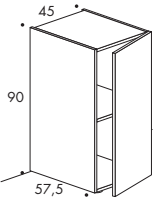

Dx





Sx



m³ 0,284

Frontale - Front - Façade - Frente - Фасад

	SMAIL	Dx SMB11511	Basic wood Basic wood • Basic wood • Basic wood • Basic wood	280	326	387
		Sx SMB11512	Frassino-Laccato opaco Ash wood-Matt lacquered • Frêne-laqué mat Madera de fresno-lacado mate • Ясень-Лак матовый	336	382	443
	LIDO	Dx SMB12511	Frassino Ash-wood • Frêne • Madera de fresno • Ясень	619	665	726
		Sx SMB12512	Laccato lucido Gloss lacquered • Laqué brillant • Lacado brillo • Лак глянец	377	423	484
	SYMPHONIA	Dx SMB14511	Frassino Ash-wood • Frêne • Madera de fresno • Ясень	518	564	625
		Sx SMB14512				

L. 60

1 anta, con 1 ripiano legno

1 door, with 1 wooden shelf • 1 porte avec 1 étagère bois • 1 puerta, con 1 estante de madera

1 дверка, с 1 деревянной полкой

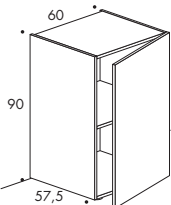

Dx





Sx



m³ 0,373

Frontale - Front - Façade - Frente - Фасад

	SMAIL	Dx SMB11521	Basic wood Basic wood • Basic wood • Basic wood • Basic wood	305	346	407
		Sx SMB11522	Frassino-Laccato opaco Ash wood-Matt lacquered • Frêne-laqué mat Madera de fresno-lacado mate • Ясень-Лак матовый	381	422	483
	LIDO	Dx SMB12521	Frassino Ash-wood • Frêne • Madera de fresno • Ясень	760	801	862
		Sx SMB12522	Laccato lucido Gloss lacquered • Laqué brillant • Lacado brillo • Лак глянец	435	476	537
	SYMPHONIA	Dx SMB14521	Frassino Ash-wood • Frêne • Madera de fresno • Ясень	667	708	769
		Sx SMB14522				

Basi a terra H.90 P.57,5 da completare con top di pag. 19

Floor base units H.90 D.57,5 to complete with top of pag. 19 • Élément base au sol H.90 P.57,5 à compléter avec le dessus de la p. 19 • Bases de tierra A.90 P.57,5 para terminar con la encimera de la pag. 19 • Напольные основания В.90 Г.57,5 добавить топ со стр. 19

Di serie con apertura PushPull. Con maniglia su frontale + 36 € cad.

Standard with PushPull opening - With handle + 36€ each one
Ouverture standard pousse-lâche - Avec poignée +36 € chaque
De serie con abertura PushPull - Con tirador + 36€ cad.

Стандартное открывание PushPull - С ручкой на фасаде + 36 €/шт.

Scocca - Carcass - Structure - Estructura - Каркас

Basic wood
Basic wood
Basic wood
Basic wood
Basic wood

Frassino-Laccato opaco
Ash wood-Matt lacquered
Frêne-laqué mat
Madera de fresno-lacado mate
Ясень-Лак матовый

Laccato lucido
Gloss lacquered
Laqué brillant
Lacado brillo
Лак глянец

L. 90

2 ante, con 1 ripiano legno

2 doors, with 1 wooden shelf • 2 portes avec 1 étagère bois • 2 puertas, con 1 estante de madera

2 дверки, с 1 деревянной полкой

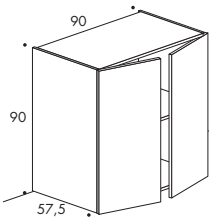

m³ 0,550

Frontale - Front - Façade - Frente - Фасад

	SMAIL	SMB11530	Basic wood Basic wood • Basic wood • Basic wood • Basic wood	391	422	482
			Frassino-Laccato opaco Ash wood-Matt lacquered • Frêne-laqué mat Madera de fresno-lacado mate • Ясень-Лак матовый	503	534	594
			Laccato lucido Gloss lacquered • Laqué brillant • Lacado brillo • Лак глянец	585	616	676
	LIDO	SMB12530	Frassino Ash-wood • Frêne • Madera de fresno • Ясень	1.069	1.100	1.160
	SYMPHONIA	SMB14530	Frassino Ash-wood • Frêne • Madera de fresno • Ясень	867	898	958

L. 120

2 ante, con 1 ripiano legno

2 doors, with 1 wooden shelf • 2 portes avec 1 étagère bois • 2 puertas, con 1 estante de madera

2 дверки, с 1 деревянной полкой

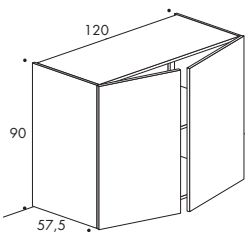

m³ 0,727

Frontale - Front - Façade - Frente - Фасад

	SMAIL	SMB11540	Basic wood Basic wood • Basic wood • Basic wood • Basic wood	459	480	504
			Frassino-Laccato opaco Ash wood-Matt lacquered • Frêne-laqué mat Madera de fresno-lacado mate • Ясень-Лак матовый	611	632	656
			Laccato lucido Gloss lacquered • Laqué brillant • Lacado brillo • Лак глянец	719	740	764
	LIDO	SMB12540	Frassino Ash-wood • Frêne • Madera de fresno • Ясень	1.369	1.390	1.414
	SYMPHONIA	SMB14540	Frassino Ash-wood • Frêne • Madera de fresno • Ясень	1.183	1.204	1.228

Basi a terra H.90 P.57,5 da completare con top di pag. 19

Floor base units H.90 D.57,5 to complete with top of pag. 19 • Élément base au sol H.90 P.57,5 à compléter avec le dessus de la p. 19 • Bases de tierra A.90 P.57,5 para terminar con la encimera de la pag. 19 • Напольные основания В.90 П.57,5 добавить топ со стр.19

Di serie con apertura PushPull. Con maniglia su frontale + 36 € cad.

Standard with PushPull opening - With handle + 36€ each one
Ouverture standard pousse-lâche - Avec poignée +36 € chaque
De serie con abertura PushPull - Con tirador + 36€ cad.

Стандартное открывание PushPull - С ручкой на фасаде + 36 €/шт.

Scocca - Carcass - Structure - Estructura - Каркас

Basic wood
Basic wood
Basic wood
Basic wood

Frassino-Laccato opaco
Ash wood-Matt lacquered
Frêne-laqué mat
Madera de fresno-lacado mate
Ясень-Лак матовый

Laccato lucido
Gloss lacquered
Laqué brillant
Lacado brillo
Лак глянец

L. 90

2 ante, con 1 ripiano legno

2 doors, with 1 wooden shelf • 2 portes avec 1 étagère bois • 2 puertas, con 1 estante de madera

2 дверки, с 1 деревянной полкой

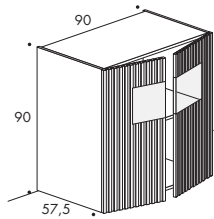

m³ 0,550

Frontale - Front - Façade - Frente - Фасад

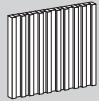

SYMPHONIA

SMB15530

Frassino
Ash-wood • Frêne • Madera de fresno • Ясень

1.045

1.076

1.136

LUCE OPTIONAL

Optional light • Eclairage optionelle
Luz opcional • Подсветка опция

SMCV1000

m³ 0,001

160

L. 120

2 ante, con 1 ripiano legno

2 doors, with 1 wooden shelf • 2 portes avec 1 étagère bois • 2 puertas, con 1 estante de madera

2 дверки, с 1 деревянной полкой

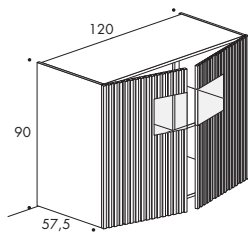

m³ 0,727

Frontale - Front - Façade - Frente - Фасад



SYMPHONIA

SMB15540

Frassino
Ash-wood • Frêne • Madera de fresno • Ясень

1.249

1.270

1.294

LUCE OPTIONAL

Optional light • Eclairage optionelle
Luz opcional • Подсветка опция

SMCV1000

m³ 0,001

160

Top basi P.58

Top base units d.58 • Dessus bases P.58 • Top bases p.58 • Столешница основания Г.58

	L.	Cod.	m ²	Finitura - Finish - Finition - Finitura - Отделка		
				Basic wood Basic wood Basic wood Basic wood	Frassino-Laccato opaco Ash wood-Matt lacquered Frêne-laqué mat Madera de fresno-lacado mate Ясень-Лак матовый	Laccato lucido Gloss lacquered Laqué brillant Lacado brillo Лак глянец

Sp. 1,8

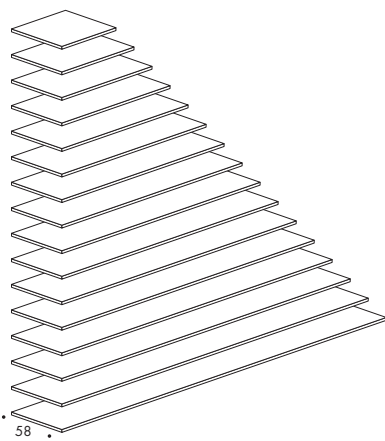

45	SMBT0210	0,006	53	69	95
60	SMBT0215	0,007	56	78	113
75	SMBT0220	0,009	60	87	132
90	SMBT0225	0,012	63	97	152
105	SMBT0230	0,013	68	106	168
120	SMBT0235	0,015	74	116	186
135	SMBT0240	0,017	79	128	208
150	SMBT0245	0,019	85	139	229
165	SMBT0250	0,020	90	151	251
180	SMBT0255	0,022	96	162	272
195	SMBT0260	0,025	101	171	288
210	SMBT0265	0,026	106	180	304
225	SMBT0270	0,028	111	189	319
240	SMBT0275	0,030	115	198	338
255	SMBT0280	0,032	119	207	357
270	SMBT0285	0,034	124	217	376

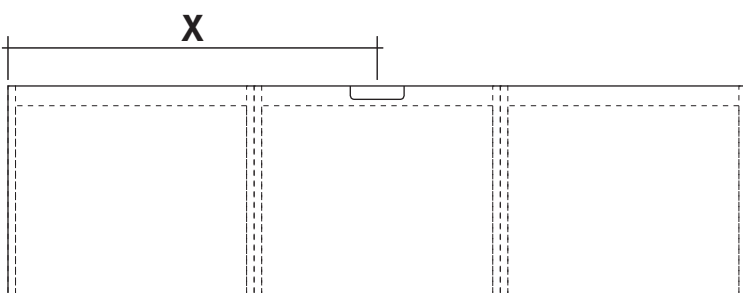

ADDEBITO PASSACAVI (L. 8 cm. x P. 2 cm.)

47

Indicare la posizione (X)

Surcharge cable glands (L.8cmxD.2cm)

Specify position (X)

Supplément découpe passage de câbles (L.8 cm x P.2 cm)

Indiquer la position (X)

Coste para guiacabos (L.8cmxP.2cm)

Indicar la posición (X)

НАЦЕНКА ЗА ОТВЕРСТИЯ ПОД КАБЕЛЪ (Д. 8 см. х ГЛ. 2 см.)

Указать расположение (X)

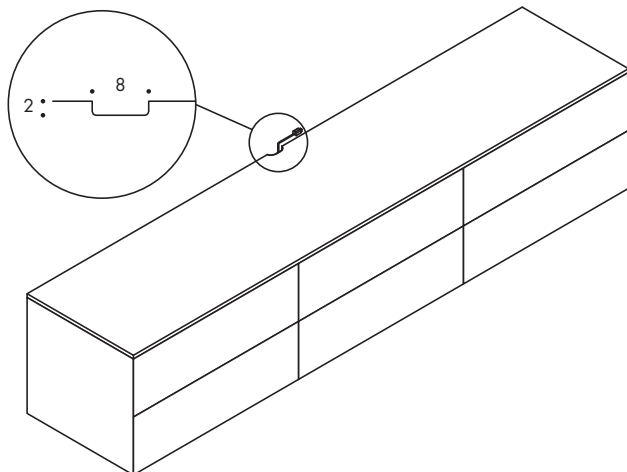

Basi a terra e sospese P.45

Floor and suspended bases D.45 • Bases au sol et suspendues P.45 • Bases de tierra y suspendida P.45 • Напольные и подвесные основания П.45

Modularità basi a terra

Floor-base modularity • Modularité bases au sol • Modularidad bases de tierra • Модульность напольных оснований

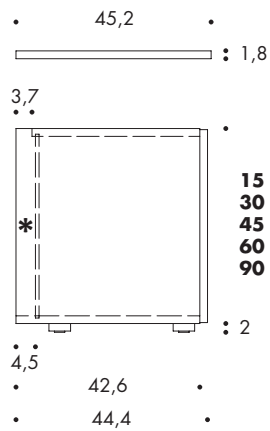
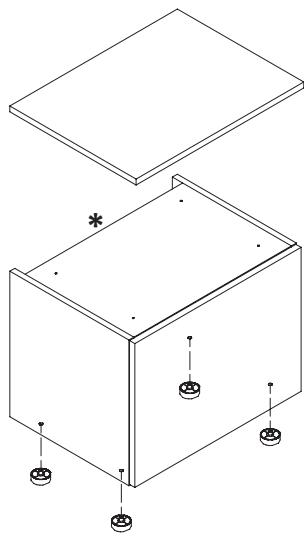

* Vuoto tecnico per passaggio cavi
Empty space for cables
Espace libre pour les câbles
Espacio para cableado
Техническое пространство для прохождения кабеля

Modularità basi sospese

Suspended bases modularity • Modularité bases suspendues • Modularidad bases suspendidas • Модульность подвесных оснований

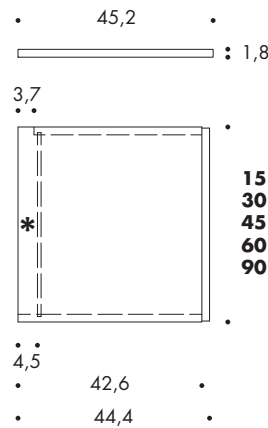
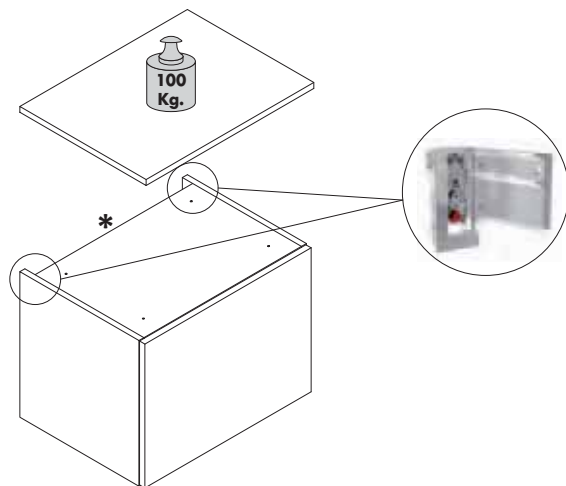

* Vuoto tecnico per passaggio cavi
Empty space for cables
Espace libre pour les câbles
Espacio para cableado
Техническое пространство для прохождения кабеля

Portata massima 100 kg uniformemente distribuiti (compreso il peso del mobile)
Maximum capacity 100 kg evenly distributed (including the weight of the cabinet)
100 kg de capacité maximale répartie uniformément (y compris le poids de l'armoire)
100 kg máxima capacidad distribuida de manera uniforme (incluyendo el peso del armario)
Макс. нагрузка 100 кг равномерно распределённых (вместе с весом модуля)

Posizione maniglia

Handle position • Position poignée • Posición del tirador • Расположение ручки

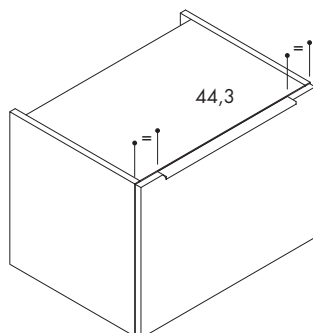





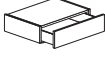
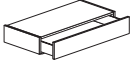
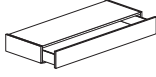

Basi a terra e sospese P.45

Floor and suspended bases D.45 • Bases au sol et suspendues P.45 • Bases de tierra y suspendida P.45 • Напольные и подвесные основания Гл.45

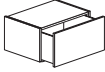
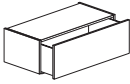
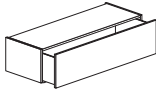
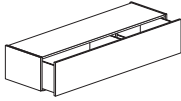
Modularità basi a terra e sospese

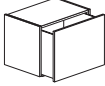
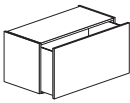
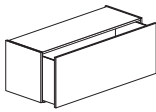
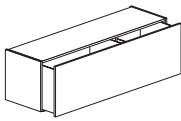
Floor and suspended bases modularity • Modularité bases au sol et suspendues • Modularidad bases de tierra y suspendidas • Модульность навесных и напольных оснований

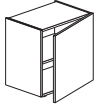
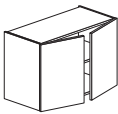
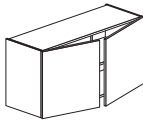
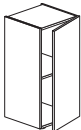
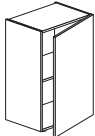
	L. 45	L. 60	L. 90	L. 120	L. 150	
H. 15						
Frontale Front Façade Frente Фасаd		SMAIL	SMAIL	SMAIL		
H. 30						
Frontale Front Façade Frente Фасаd	SMAIL	SMAIL	SMAIL	SMAIL	SMAIL	
		LIDO	LIDO	LIDO	LIDO	
H. 45						
Frontale Front Façade Frente Фасаd	SMAIL	SMAIL	SMAIL	SMAIL	SMAIL	
		LIDO	LIDO	LIDO	LIDO	
H. 60						
Frontale Front Façade Frente Фасаd	SMAIL	SMAIL	SMAIL	SMAIL		
		GENESIS		GENESIS		
	LIDO	LIDO	LIDO	LIDO		
	SYMPHONIA	SYMPHONIA	SYMPHONIA	SYMPHONIA		
H. 90						
Frontale Front Façade Frente Фасаd	SMAIL	SMAIL				
	LIDO	LIDO				
	SYMPHONIA	SYMPHONIA				

Basi a terra H.15 P.45 da completare con top di pag. 39

Floor base units H.15 D.45 to complete with top of pag.39 • Élément base au sol H.15 P.45 à compléter avec le dessus de la p. 39 • Bases de tierra A.15 P.45 para terminar con la encimera de la pag.39 • Напольные основания H15Г45 добавить топ со стр.39

**Di serie con apertura PushPull.
Con maniglia su frontale + 36 € cad. - Con guide ad estrazione totale + 30 € cad.**

Standard with PushPull opening - With handle + 36€ each one - With full extension slides + 30€ each
Ouverture standard pousse-lâche - Avec poignée +36 € chaque - Avec coulisses pleine extension + 30€ caque
De serie con abertura PushPull - Con tirador + 36€ cad. - Con deslizadores de extension total + 30€ cad.
Стандартное открывание PushPull - С ручкой на фасаде + 36 €/шт. - С направляющими полного выдвижения +30 €/шт.

Socca - Carcass - Structure - Estructura - Каркас

Basic wood
Basic wood
Basic wood
Basic wood

Frassino-Laccato opaco
Ash wood-Matt lacquered
Frêne-laqué mat
Madera de fresno-lacado mate
Ясень-Лак матовый

Laccato lucido
Gloss lacquered
Laqué brillant
Lacado brillo
Лак глянец

L. 60

1 cassetto
1 drawer • 1 tiroir • 1 cajon • 1 ящик

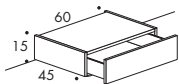

m³ 0,057

Frontale - Front - Façade - Frente - Фасад

	SMAIL	SMB21120	Basic wood Basic wood • Basic wood • Basic wood • Basic wood	196	189	196
			Frassino-Laccato opaco Ash wood-Matt lacquered • Frêne-laqué mat Madera de fresno-lacado mate • Ясень-Лак матовый	209	202	209
			Laccato lucido Gloss lacquered • Laqué brillant • Lacado brillo • Лак глянец	217	210	217

L. 90

1 cassetto
1 drawer • 1 tiroir • 1 cajon • 1 ящик

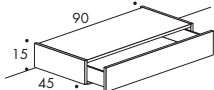

m³ 0,084

Frontale - Front - Façade - Frente - Фасад

	SMAIL	SMB21130	Basic wood Basic wood • Basic wood • Basic wood • Basic wood	219	210	220
			Frassino-Laccato opaco Ash wood-Matt lacquered • Frêne-laqué mat Madera de fresno-lacado mate • Ясень-Лак матовый	237	228	238
			Laccato lucido Gloss lacquered • Laqué brillant • Lacado brillo • Лак глянец	250	241	251

L. 120

1 cassetto
1 drawer • 1 tiroir • 1 cajon • 1 ящик

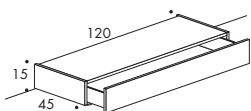

m³ 0,112

Frontale - Front - Façade - Frente - Фасад

	SMAIL	SMB21140	Basic wood Basic wood • Basic wood • Basic wood • Basic wood	263	252	258
			Frassino-Laccato opaco Ash wood-Matt lacquered • Frêne-laqué mat Madera de fresno-lacado mate • Ясень-Лак матовый	288	277	283
			Laccato lucido Gloss lacquered • Laqué brillant • Lacado brillo • Лак глянец	305	294	300

Basi a terra H.30 P.45 da completare con top di pag. 39

Floor base units H.30 D.45 to complete with top of pag.39 • Élément base au sol H.30 P.45 à compléter avec le dessus de la p. 39 • Bases de tierra A.30 P.45 para terminar con la encimera de la pag.39 • Напольные основания В.30 Г.45 добавить топ со стр. 39

Di serie con apertura PushPull. Con maniglia su frontale + 36 € cad. - Con guide ad estrazione totale + 30 € cad.

Standard with PushPull opening - With handle + 36€ each one - With full extension slides + 30€ each
Ouverture standard pousse-lâche - Avec poignée +36 € chaque - Avec coulisses pleine extension + 30€ caque
De serie con apertura PushPull - Con tirador + 36€ cad. - Con deslizadores de extension total + 30€ cad.
Стандартное открывание PushPull - С ручкой на фасаде + 36 €/шт. - С направляющими полного выдвижения +30 €/шт.

Scocca - Carcass - Structure - Estructura - Каркас

Basic wood
Basic wood
Basic wood
Basic wood
Basic wood

Frassino-Laccato opaco
Ash wood-Matt lacquered
Frêne-laqué mat
Madera de fresno-lacado mate
Ясень-Лак матовый

Laccato lucido
Gloss lacquered
Laqué brillant
Lacado brillo
Лак глянец

L. 45

1 cassettone

1 big-drawer • 1 gros tiroir • 1 cajon grande • 1 глубокий ящик

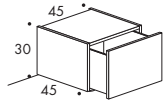

m³ 0,080

Frontale - Front - Façade - Frente - Фасад

	SMAIL	SMB21210	Basic wood Basic wood • Basic wood • Basic wood • Basic wood	204	218	235
			Frassino-Laccato opaco Ash wood-Matt lacquered • Frêne-laqué mat Madera de fresno-lacado mate • Ясень-Лак матовый	222	236	253
			Laccato lucido Gloss lacquered • Laqué brillant • Lacado brillo • Лак глянец	236	250	267

L. 60

1 cassettone

1 big-drawer • 1 gros tiroir • 1 cajon grande • 1 глубокий ящик

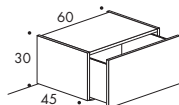

m³ 0,105

Frontale - Front - Façade - Frente - Фасад

	SMAIL	SMB21220	Basic wood Basic wood • Basic wood • Basic wood • Basic wood	219	229	245
			Frassino-Laccato opaco Ash wood-Matt lacquered • Frêne-laqué mat Madera de fresno-lacado mate • Ясень-Лак матовый	244	254	270
			Laccato lucido Gloss lacquered • Laqué brillant • Lacado brillo • Лак глянец	261	271	287
	LIDO	SMB22220	Frassino Ash-wood • Frêne • Madera de fresno • Ясень	384	394	410

L. 90

1 cassettone

1 big-drawer • 1 gros tiroir • 1 cajon grande • 1 глубокий ящик

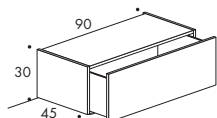

m³ 0,155

Frontale - Front - Façade - Frente - Фасад

	SMAIL	SMB21230	Basic wood Basic wood • Basic wood • Basic wood • Basic wood	248	253	270
			Frassino-Laccato opaco Ash wood-Matt lacquered • Frêne-laqué mat Madera de fresno-lacado mate • Ясень-Лак матовый	284	289	306
			Laccato lucido Gloss lacquered • Laqué brillant • Lacado brillo • Лак глянец	309	314	331
	LIDO	SMB22230	Frassino Ash-wood • Frêne • Madera de fresno • Ясень	486	491	508

Basi a terra H.30 P.45 da completare con top di pag. 39

Floor base units H.30 D.45 to complete with top of pag.39 • Élément base au sol H.30 P.45 à compléter avec le dessus de la p. 39 • Bases de tierra A.30 P.45 para terminar con la encimera de la pag.39 • Напольные основания В.30Г.45 добавить топ со стр. 39

Di serie con apertura PushPull. Con maniglia su frontale + 36 € cad. - Con guide ad estrazione totale + 30 € cad.

Standard with PushPull opening - With handle + 36€ each one - With full extension slides + 30€ each
Ouverture standard pousse-lâche - Avec poignée +36 € chaque - Avec coulisses pleine extension + 30€ caque
De serie con abertura PushPull - Con tirador + 36€ cad. - Con deslizadores de extension total + 30€ cad.
Стандартное открывание PushPull - С ручкой на фасаде + 36 €/шт. - С направляющими полного выдвижения +30 €/шт.

Socca - Carcass - Structure - Estructura - Каркас

Basic wood Basic wood Basic wood Basic wood	Frassino-Laccato opaco Ash wood-Matt lacquered Frêne-laqué mat Madera de fresno-lacado mate Ясень-Лак матовый	Laccato lucido Gloss lacquered Laqué brillant Lacado brillo Лак глянец
--	---	--

L. 120

1 cassettone
1 big-drawer • 1 gros tiroir • 1 cajon grande • 1 глубокий ящик

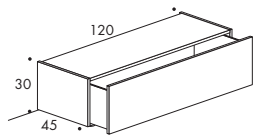

m³ 0,205

Frontale - Front - Façade - Frente - Фасад

	SMail	SMB21240	Basic wood Basic wood • Basic wood • Basic wood • Basic wood	293	293	309
			Frassino-Laccato opaco Ash wood-Matt lacquered • Frêne-laqué mat Madera de fresno-lacado mate • Ясень-Лак матовый	344	344	360
			Laccato lucido Gloss lacquered • Laqué brillant • Lacado brillo • Лак глянец	379	379	395
	LIDO	SMB22240	Frassino Ash-wood • Frêne • Madera de fresno • Ясень	596	596	612

L. 150

1 cassettone (internamente diviso 90+60)
1 big-drawer (internally 90+60) • 1 gros tiroir (divisé intérieurement en 90+60) • 1 cajon grande (interior 90+60)
1 глубокий ящик (разделён внутри 90+60)

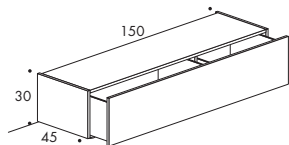

m³ 0,255

Frontale - Front - Façade - Frente - Фасад

	SMail	SMB21250	Basic wood Basic wood • Basic wood • Basic wood • Basic wood	354	348	364
			Frassino-Laccato opaco Ash wood-Matt lacquered • Frêne-laqué mat Madera de fresno-lacado mate • Ясень-Лак матовый	416	410	426
			Laccato lucido Gloss lacquered • Laqué brillant • Lacado brillo • Лак глянец	457	451	467
	LIDO	SMB22250	Frassino Ash-wood • Frêne • Madera de fresno • Ясень	690	684	700

Basi a terra H.45 P.45 da completare con top di pag. 39

Floor base units H.45 D.45 to complete with top of pag.39 • Élément base au sol H.45 P.45 à compléter avec le dessus de la p. 39 • Bases de tierra A.45 P.45 para terminar con la encimera de la pag.39 • Напольные основания В.45 П.45 добавить топ со стр. 39

Di serie con apertura PushPull. Con maniglia su frontale + 36 € cad. - Con guide ad estrazione totale + 30 € cad.

Standard with PushPull opening - With handle + 36€ each one - With full extension slides + 30€ each
Ouverture standard pousse-lâche - Avec poignée +36 € chaque - Avec coulisses pleine extension + 30€ chaque
De serie con apertura PushPull - Con tirador + 36€ cad. - Con deslizadores de extension total + 30€ cad.
Стандартное открывание PushPull - С ручкой на фасаде + 36 €/шт. - С направляющими полного выдвижения +30 €/шт.

Scocca - Carcass - Structure - Estructura - Каркас

Basic wood
Basic wood
Basic wood
Basic wood
Basic wood

Frassino-Laccato opaco
Ash wood-Matt lacquered
Frêne-laqué mat
Madera de fresno-lacado mate
Ясень-Лак матовый

Laccato lucido
Gloss lacquered
Laqué brillant
Lacado brillo
Лак глянец

L. 45

1 cassettone

1 big-drawer • 1 gros tiroir • 1 cajon grande • 1 глубокий ящик

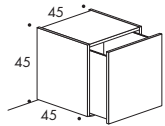

m³ 0,116

Frontale - Front - Façade - Frente - Фасад

	SMAIL	SMB21310	Basic wood Basic wood • Basic wood • Basic wood • Basic wood	216	237	262
			Frassino-Laccato opaco Ash wood-Matt lacquered • Frêne-laqué mat Madera de fresno-lacado mate • Ясень-Лак матовый	243	264	289
			Laccato lucido Gloss lacquered • Laqué brillant • Lacado brillo • Лак глянец	263	284	309

L. 60

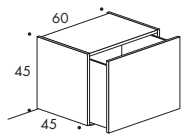

1 cassettone

1 big-drawer • 1 gros tiroir • 1 cajon grande • 1 глубокий ящик



m³ 0,153

Frontale - Front - Façade - Frente - Фасад

	SMAIL	SMB21320	Basic wood Basic wood • Basic wood • Basic wood • Basic wood	230	248	272
			Frassino-Laccato opaco Ash wood-Matt lacquered • Frêne-laqué mat Madera de fresno-lacado mate • Ясень-Лак матовый	268	286	310
			Laccato lucido Gloss lacquered • Laqué brillant • Lacado brillo • Лак глянец	294	312	336
	LIDO	SMB22320	Frassino Ash-wood • Frêne • Madera de fresno • Ясень	476	494	518

L. 90

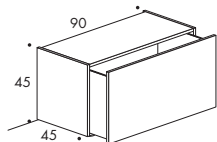

1 cassettone

1 big-drawer • 1 gros tiroir • 1 cajon grande • 1 глубокий ящик



m³ 0,225

Frontale - Front - Façade - Frente - Фасад

	SMAIL	SMB21330	Basic wood Basic wood • Basic wood • Basic wood • Basic wood	264	275	300
			Frassino-Laccato opaco Ash wood-Matt lacquered • Frêne-laqué mat Madera de fresno-lacado mate • Ясень-Лак матовый	321	332	357
			Laccato lucido Gloss lacquered • Laqué brillant • Lacado brillo • Лак глянец	360	371	396
	LIDO	SMB22330	Frassino Ash-wood • Frêne • Madera de fresno • Ясень	598	609	634

Basi a terra H.45 P.45 da completare con top di pag. 39

Floor base units H.45 D.45 to complete with top of pag.39 • Élément base au sol H.45 P.45 à compléter avec le dessus de la p. 39 • Bases de tierra A.45 P.45 para terminar con la encimera de la pag.39 • Напольные основания В.45 Г.45 добавить топ со стр. 39

Di serie con apertura PushPull. Con maniglia su frontale + 36 € cad. - Con guide ad estrazione totale + 30 € cad.

Standard with PushPull opening - With handle + 36€ each one - With full extension slides + 30€ each
Ouverture standard pousse-lâche - Avec poignée +36 € chaque - Avec coulisses pleine extension + 30€ caque
De serie con abertura PushPull - Con tirador + 36€ cad. - Con deslizadores de extension total + 30€ cad.
Стандартное открывание PushPull - С ручкой на фасаде + 36 €/шт. - С направляющими полного выдвижения +30 €/шт.

Scocca - Carcass - Structure - Estructura - Каркас

Basic wood
Basic wood
Basic wood
Basic wood

Frassino-Laccato opaco
Ash wood-Matt lacquered
Frêne-laqué mat
Madera de fresno-lacado mate
Ясень-Лак матовый

Laccato lucido
Gloss lacquered
Laqué brillant
Lacado brillo
Лак глянец

L. 120

1 cassettone
1 big-drawer • 1 gros tiroir • 1 cajon grande • 1 глубокий ящик

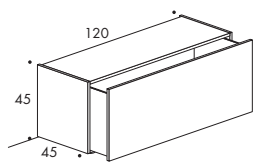

m³ 0,298

Frontale - Front - Façade - Frente - Фасад

	SMail	SMB21340	Basic wood Basic wood • Basic wood • Basic wood • Basic wood	311	318	342
			Frassino-Laccato opaco Ash wood-Matt lacquered • Frêne-laqué mat Madera de fresno-lacado mate • Ясень-Лак матовый	387	394	418
			Laccato lucido Gloss lacquered • Laqué brillant • Lacado brillo • Лак глянец	441	448	472
	LIDO	SMB22340	Frassino Ash-wood • Frêne • Madera de fresno • Ясень	746	753	777

L. 150

1 cassettone (internamente diviso 90+60)
1 big-drawer (internally 90+60) • 1 gros tiroir (divisé intérieurement en 90+60) • 1 cajon grande (interior 90+60)
• 1 глубокий ящик (разделён внутри 90+60)

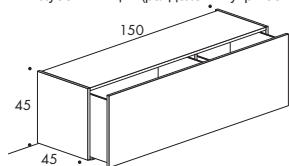

m³ 0,370

Frontale - Front - Façade - Frente - Фасад

	SMail	SMB21350	Basic wood Basic wood • Basic wood • Basic wood • Basic wood	375	377	422
			Frassino-Laccato opaco Ash wood-Matt lacquered • Frêne-laqué mat Madera de fresno-lacado mate • Ясень-Лак матовый	469	471	516
			Laccato lucido Gloss lacquered • Laqué brillant • Lacado brillo • Лак глянец	537	539	584
	LIDO	SMB22350	Frassino Ash-wood • Frêne • Madera de fresno • Ясень	896	898	943

Basi a terra H.60 P.45 da completare con top di pag. 39

Floor base units H.60 D.45 to complete with top of pag.39 • Élément base au sol H.60 P.45 à compléter avec le dessus de la p. 39 • Bases de tierra A.60 P.45 para terminar con la encimera de la pag.39 • Напольные основания В.60 Г.45 добавить топ со стр. 39

Di serie con apertura PushPull. Con maniglia su frontale + 36 € cad.

Standard with PushPull opening - With handle + 36€ each one
Ouverture standard pousse-lâche - Avec poignée +36 € chaque
De serie con abertura PushPull - Con tirador + 36€ cad.

Стандартное открывание PushPull - С ручкой на фасаде + 36 €/шт.

Scocca - Carcass - Structure - Estructura - Каркас

Basic wood
Basic wood
Basic wood
Basic wood

Frassino-Laccato opaco
Ash wood-Matt lacquered
Frêne-laqué mat
Madera de fresno-lacado mate
Ясень-Лак матовый

Laccato lucido
Gloss lacquered
Laqué brillant
Lacado brillo
Лак глянец

L. 45

1 anta, con 1 ripiano legno

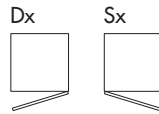
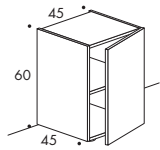

1 door, with 1 wooden shelf • 1 porte avec 1 étagère bois • 1 puerta, con 1 estante de madera

1 дверка, с 1 деревянной полкой



m³ 0,153

Frontale - Front - Façade - Frente - Фасад

	SMAIL	Dx SMB21411	Basic wood Basic wood • Basic wood • Basic wood • Basic wood	235	259	292
		Sx SMB21412	Frassino-Laccato opaco Ash wood-Matt lacquered • Frêne-laqué mat Madera de fresno-lacado mate • Ясень-Лак матовый	272	296	329
	LIDO	Dx SMB22411	Frassino Ash-wood • Frêne • Madera de fresno • Ясень	480	504	537
		Sx SMB22412	Laccato lucido Gloss lacquered • Laqué brillant • Lacado brillo • Лак глянец	298	322	355
	SYMPHONIA	Dx SMB24411	Frassino Ash-wood • Frêne • Madera de fresno • Ясень	408	432	465
		Sx SMB24412				

L. 60

1 anta, con 1 ripiano legno



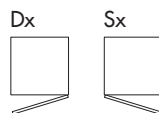
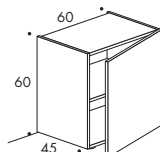

1 door, with 1 wooden shelf • 1 porte avec 1 étagère bois • 1 puerta, con 1 estante de madera

1 дверка, с 1 деревянной полкой



m³ 0,200

Frontale - Front - Façade - Frente - Фасад

	SMAIL	Dx SMB21421	Basic wood Basic wood • Basic wood • Basic wood • Basic wood	250	270	302
		Sx SMB21422	Frassino-Laccato opaco Ash wood-Matt lacquered • Frêne-laqué mat Madera de fresno-lacado mate • Ясень-Лак матовый	300	320	352
	GENESIS No pushpull No pushpull • No pousse-lâche No pushpull • Не может быть push-pull	Dx SMB23421	Frassino-Laccato opaco Ash wood-matt lacquered • Frêne-laqué mat Madera de fresno-lacado mate • Ясень-Лак матовый	397	417	449
		Sx SMB23422				
	LIDO	Dx SMB22421	Frassino Ash-wood • Frêne • Madera de fresno • Ясень	561	581	613
		Sx SMB22422				
	SYMPHONIA	Dx SMB24421	Frassino Ash-wood • Frêne • Madera de fresno • Ясень	519	539	571
		Sx SMB24422				

Basi a terra H.60 P.45 da completare con top di pag. 39

Floor base units H.60 D.45 to complete with top of pag.39 • Élément base au sol H.60 P.45 à compléter avec le dessus de la p. 39 • Bases de tierra A.60 P.45 para terminar con la encimera de la pag.39 • Напольные основания H.60 P.45 добавить топ со стр. 39

Di serie con apertura PushPull. Con maniglia su frontale + 36 € cad.

Standard with PushPull opening - With handle + 36€ each one

Ouverture standard pousse-lâche - Avec poignée +36 € chaque

De serie con abertura PushPull - Con tirador + 36€ cad.

Стандартное открывание PushPull - С ручкой на фасаде + 36 €/шт.

Scocca - Carcass - Structure - Estructura - Каркас

Basic wood
Basic wood
Basic wood
Basic wood
Basic wood

Frassino-Laccato opaco
Ash wood-Matt lacquered
Frêne-laqué mat
Madera de fresno-lacado mate
Ясень-Лак матовый

Laccato lucido
Gloss lacquered
Laqué brillant
Lacado brillo
Лак глянец

L. 90

2 ante, con 1 ripiano legno

2 doors, with 1 wooden shelf • 2 portes avec 1 étagère bois • 2 puertas, con 1 estante de madera

2 дверки, с 1 деревянной полкой

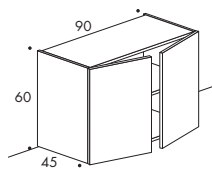

m³ 0,295

Frontale - Front - Façade - Frente - Фасад

	SMAIL	SMB21430	Basic wood Basic wood • Basic wood • Basic wood • Basic wood	332	343	377
			Frassino-Laccato opaco Ash wood-Matt lacquered • Frêne-laqué mat Madera de fresno-lacado mate • Ясень-Лак матовый	406	417	451
			Laccato lucido Gloss lacquered • Laqué brillant • Lacado brillo • Лак глянец	458	469	503
	LIDO	SMB22430	Frassino Ash-wood • Frêne • Madera de fresno • Ясень	822	833	867
	SYMPHONIA	SMB24430	Frassino Ash-wood • Frêne • Madera de fresno • Ясень	678	689	723

L. 120

2 ante, con 1 ripiano legno

2 doors, with 1 wooden shelf • 2 portes avec 1 étagère bois • 2 puertas, con 1 estante de madera

2 дверки, с 1 деревянной полкой

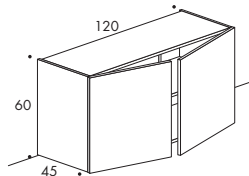

m³ 0,390

Frontale - Front - Façade - Frente - Фасад

	SMAIL	SMB21440	Basic wood Basic wood • Basic wood • Basic wood • Basic wood	391	396	429
			Frassino-Laccato opaco Ash wood-Matt lacquered • Frêne-laqué mat Madera de fresno-lacado mate • Ясень-Лак матовый	491	496	529
			Laccato lucido Gloss lacquered • Laqué brillant • Lacado brillo • Лак глянец	563	568	601
	GENESIS No pushpull No pushpull • No pousse-lâche No pushpull • Не может быть push-pull	SMB23440	Frassino-Laccato opaco Ash wood-matt lacquered • Frêne-laqué mat Madera de fresno-lacado mate • Ясень-Лак матовый	685	690	723
	LIDO	SMB22440	Frassino Ash-wood • Frêne • Madera de fresno • Ясень	1.013	1.018	1.051
	SYMPHONIA	SMB24440	Frassino Ash-wood • Frêne • Madera de fresno • Ясень	929	934	967

Basi a terra H.90 P.45 da completare con top di pag. 39

Floor base units H.90 D.45 to complete with top of pag.39 • Élément base au sol H.90 P.45 à compléter avec le dessus de la p. 39 • Bases de tierra A.90 P.45 para terminar con la encimera de la pag.39 • Напольные основания В.90 Г.45 добавить топ со стр. 39

Di serie con apertura PushPull. Con maniglia su frontale + 36 € cad.

Standard with PushPull opening - With handle + 36€ each one
Ouverture standard pousse-lâche - Avec poignée +36 € chaque
De serie con abertura PushPull - Con tirador + 36€ cad.

Стандартное открывание PushPull - С ручкой на фасаде + 36 €/шт.

Scocca - Carcass - Structure - Estructura - Каркас

Basic wood
Basic wood
Basic wood
Basic wood

Frassino-Laccato opaco
Ash wood-Matt lacquered
Frêne-laqué mat
Madera de fresno-lacado mate
Ясень-Лак матовый

Laccato lucido
Gloss lacquered
Laqué brillant
Lacado brillo
Лак глянец

L. 45

1 anta, con 1 ripiano legno

1 door, with 1 wooden shelf • 1 porte avec 1 étagère bois • 1 puerta, con 1 estante de madera

1 дверка, с 1 деревянной полкой

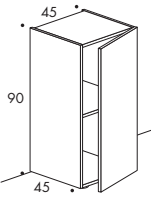

Dx





Sx



m³ 0,225

Frontale - Front - Façade - Frente - Фасад

	SMAIL	Dx SMB21511	Basic wood Basic wood • Basic wood • Basic wood • Basic wood	257	283	314
		Sx SMB21512	Frassino-Laccato opaco Ash wood-Matt lacquered • Frêne-laqué mat Madera de fresno-lacado mate • Ясень-Лак матовый	313	339	370
	LIDO	Dx SMB22511	Frassino Ash-wood • Frêne • Madera de fresno • Ясень	596	622	653
		Sx SMB22512	Laccato lucido Gloss lacquered • Laqué brillant • Lacado brillo • Лак глянец	354	380	411
	SYMPHONIA	Dx SMB24511	Frassino Ash-wood • Frêne • Madera de fresno • Ясень	495	521	552
		Sx SMB24512				

L. 60

1 anta, con 1 ripiano legno

1 door, with 1 wooden shelf • 1 porte avec 1 étagère bois • 1 puerta, con 1 estante de madera

1 дверка, с 1 деревянной полкой

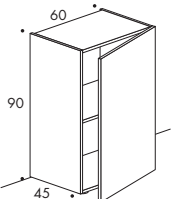

Dx





Sx



m³ 0,295

Frontale - Front - Façade - Frente - Фасад

	SMAIL	Dx SMB21521	Basic wood Basic wood • Basic wood • Basic wood • Basic wood	282	317	360
		Sx SMB21522	Frassino-Laccato opaco Ash wood-Matt lacquered • Frêne-laqué mat Madera de fresno-lacado mate • Ясень-Лак матовый	358	393	436
	LIDO	Dx SMB22521	Frassino Ash-wood • Frêne • Madera de fresno • Ясень	737	772	815
		Sx SMB22522	Laccato lucido Gloss lacquered • Laqué brillant • Lacado brillo • Лак глянец	412	447	490
	SYMPHONIA	Dx SMB24521	Frassino Ash-wood • Frêne • Madera de fresno • Ясень	644	679	722
		Sx SMB24522				

Basi sospese H.15 P.45 da completare con top di pag. 39

Suspended base units H.15 D.45 to complete with top of pag.39 • Élément base suspendue H.15 P.45 à compléter avec le dessus de la p. 39 • Bases de suspensión A.15 P.45 para terminar con la encimera de la pag.39 • Подвесные основания H.15 P.45 добавитe топ со стр.39

Di serie con apertura PushPull.
Con maniglia su frontale + 36 € cad. - Con guide ad estrazione totale + 30 € cad.

Standard with PushPull opening - With handle + 36€ each one - With full extension slides + 30€ each
 Ouverture standard pousse-lâche - Avec poignée +36 € chaque - Avec coulisses pleine extension + 30€ caque
 De serie con abertura PushPull - Con tirador + 36€ cad. - Con deslizadores de extension total + 30€ cad.
 Стандартное открытие PushPull - С ручкой на фасаде + 36 €/шт. - С направляющими полного выдвижения +30 €/шт.

Socca - Carcass - Structure - Estructura - Каркас

Basic wood
 Basic wood
 Basic wood
 Basic wood
 Basic wood

Frassino-Laccato opaco
 Ash wood-Matt lacquered
 Frêne-laqué mat
 Madera de fresno-lacado mate
 Ясень-Лак матовый

Laccato lucido
 Gloss lacquered
 Laqué brillant
 Lacado brillo
 Лак глянец

L. 60

1 cassetto
 1 drawer • 1 tiroir • 1 cajon • 1 ящик

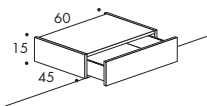

m³ 0,057

Frontale - Front - Façade - Frente - Фасад

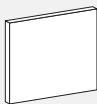
	SMAIL	SMB31120	Basic wood Basic wood • Basic wood • Basic wood • Basic wood	221	214	221
			Frassino-Laccato opaco Ash wood-Matt lacquered • Frêne-laqué mat Madera de fresno-lacado mate • Ясень-Лак матовый	234	227	234
			Laccato lucido Gloss lacquered • Laqué brillant • Lacado brillo • Лак глянец	242	235	242

L. 90

1 cassetto
 1 drawer • 1 tiroir • 1 cajon • 1 ящик

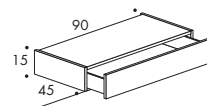

m³ 0,084

Frontale - Front - Façade - Frente - Фасад

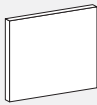
	SMAIL	SMB31130	Basic wood Basic wood • Basic wood • Basic wood • Basic wood	244	235	245
			Frassino-Laccato opaco Ash wood-Matt lacquered • Frêne-laqué mat Madera de fresno-lacado mate • Ясень-Лак матовый	262	253	263
			Laccato lucido Gloss lacquered • Laqué brillant • Lacado brillo • Лак глянец	275	266	276

L. 120

1 cassetto
 1 drawer • 1 tiroir • 1 cajon • 1 ящик

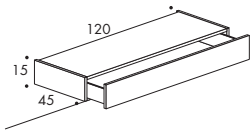

m³ 0,112

Frontale - Front - Façade - Frente - Фасад

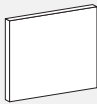
	SMAIL	SMB31140	Basic wood Basic wood • Basic wood • Basic wood • Basic wood	288	277	283
			Frassino-Laccato opaco Ash wood-Matt lacquered • Frêne-laqué mat Madera de fresno-lacado mate • Ясень-Лак матовый	313	302	308
			Laccato lucido Gloss lacquered • Laqué brillant • Lacado brillo • Лак глянец	330	319	325

Basi sospese H.30 P.45 da completare con top di pag. 39

Suspended base units H.30 D.45 to complete with top of pag.39 • Élément base suspendue H.30 P.45 à compléter avec le dessus de la p. 39 • Bases de suspensión A.30 P.45 para terminar con la encimera de la pag.39 • Подвесные основания В.30 Г.45 добавить топ со стр.39

Di serie con apertura PushPull.

Con maniglia su frontale + 36 € cad. - Con guide ad estrazione totale + 30 € cad.

Standard with PushPull opening - With handle + 36€ each one - With full extension slides + 30€ each

Ouverture standard pousse-lâche - Avec poignée +36 € chaque - Avec coulisses pleine extension + 30€ chaque

De serie con apertura PushPull - Con tirador + 36€ cad. - Con deslizador de extension total + 30€ cad.

Стандартное открывание PushPull - С ручкой на фасаде + 36 €/шт. - С направляющими полного выдвижения +30 €/шт.

Scocca - Carcass - Structure - Estructura - Каркас

Basic wood
Basic wood
Basic wood
Basic wood
Basic wood

Frassino-Laccato opaco
Ash wood-Matt lacquered
Frêne-laqué mat
Madera de fresno-lacado mate
Ясень-Лак матовый

Laccato lucido
Gloss lacquered
Laqué brillant
Lacado brillo
Лак глянец

L. 45

1 cassettone

1 big-drawer • 1 gros tiroir • 1 cajon grande • 1 глубокий ящик

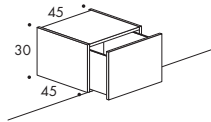

m³ 0,080

Frontale - Front - Façade - Frente - Фасад

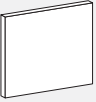
	SMAIL	SMB31210	Basic wood Basic wood • Basic wood • Basic wood • Basic wood	229	243	260
			Frassino-Laccato opaco Ash wood-Matt lacquered • Frêne-laqué mat Madera de fresno-lacado mate • Ясень-Лак матовый	247	261	278
			Laccato lucido Gloss lacquered • Laqué brillant • Lacado brillo • Лак глянец	261	275	292

L. 60

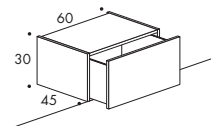

1 cassettone

1 big-drawer • 1 gros tiroir • 1 cajon grande • 1 глубокий ящик

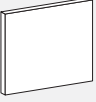

m³ 0,105

Frontale - Front - Façade - Frente - Фасад

	SMAIL	SMB31220	Basic wood Basic wood • Basic wood • Basic wood • Basic wood	244	254	270
			Frassino-Laccato opaco Ash wood-Matt lacquered • Frêne-laqué mat Madera de fresno-lacado mate • Ясень-Лак матовый	269	279	295
			Laccato lucido Gloss lacquered • Laqué brillant • Lacado brillo • Лак глянец	286	296	312
	LIDO	SMB32220	Frassino Ash-wood • Frêne • Madera de fresno • Ясень	409	419	435

L. 90

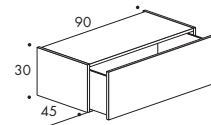

1 cassettone

1 big-drawer • 1 gros tiroir • 1 cajon grande • 1 глубокий ящик

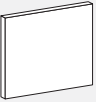

m³ 0,155

Frontale - Front - Façade - Frente - Фасад

	SMAIL	SMB31230	Basic wood Basic wood • Basic wood • Basic wood • Basic wood	273	278	295
			Frassino-Laccato opaco Ash wood-Matt lacquered • Frêne-laqué mat Madera de fresno-lacado mate • Ясень-Лак матовый	309	314	331
			Laccato lucido Gloss lacquered • Laqué brillant • Lacado brillo • Лак глянец	334	339	356
	LIDO	SMB32230	Frassino Ash-wood • Frêne • Madera de fresno • Ясень	511	516	533

Basi sospese H.30 P.45 da completare con top di pag. 39

Suspended base units H.30 D.45 to complete with top of pag.39 • Élément base suspendue H.30 P.45 à compléter avec le dessus de la p. 39 • Bases de suspensión A.30 P.45 para terminar con la encimera de la pag.39 • Подвесные основания В.30 П.45 добавить топ со стр.39

Di serie con apertura PushPull. Con maniglia su frontale + 36 € cad. - Con guide ad estrazione totale + 30 € cad.

Standard with PushPull opening - With handle + 36€ each one - With full extension slides + 30€ each
Ouverture standard pousse-lâche - Avec poignée +36 € chaque - Avec coulisses pleine extension + 30€ chaque
De serie con abertura PushPull - Con tirador + 36€ cad. - Con deslizadores de extension total + 30€ cad.
Стандартное открывание PushPull - С ручкой на фасаде + 36 €/шт. - С направляющими полного выдвижения +30 €/шт.

Socca - Carcass - Structure - Estructura - Каркас

Basic wood
Basic wood
Basic wood
Basic wood

Frassino-Laccato opaco
Ash wood-Matt lacquered
Frêne-laqué mat
Madera de fresno-lacado mate
Ясень-Лак матовый

Laccato lucido
Gloss lacquered
Laqué brillant
Lacado brillo
Лак глянец

L. 120

1 cassettone

1 big-drawer • 1 gros tiroir • 1 cajon grande • 1 глубокий ящик

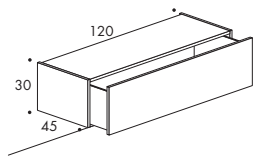

m³ 0,205

Frontale - Front - Façade - Frente - Фасад

	SMAIL	SMB31240	Basic wood Basic wood • Basic wood • Basic wood • Basic wood	318	318	334
			Frassino-Laccato opaco Ash wood-Matt lacquered • Frêne-laqué mat Madera de fresno-lacado mate • Ясень-Лак матовый	369	369	385
			Laccato lucido Gloss lacquered • Laqué brillant • Lacado brillo • Лак глянец	404	404	420
	LIDO	SMB32240	Frassino Ash-wood • Frêne • Madera de fresno • Ясень	621	621	637

L. 150

1 cassettone (internamente diviso 90+60)

1 big-drawer (internally 90+60) • 1 gros tiroir (divisé intérieurement en 90+60) • 1 cajon grande (interior 90+60)

1 глубокий ящик (разделён внутри 90+60)

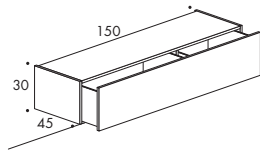

m³ 0,255

Frontale - Front - Façade - Frente - Фасад

	SMAIL	SMB31250	Basic wood Basic wood • Basic wood • Basic wood • Basic wood	379	373	389
			Frassino-Laccato opaco Ash wood-Matt lacquered • Frêne-laqué mat Madera de fresno-lacado mate • Ясень-Лак матовый	441	435	451
			Laccato lucido Gloss lacquered • Laqué brillant • Lacado brillo • Лак глянец	482	476	492
	LIDO	SMB32250	Frassino Ash-wood • Frêne • Madera de fresno • Ясень	715	709	725

Basi sospese H.45 P.45 da completare con top di pag. 39

Suspended base units H.45 D.45 to complete with top of pag.39 • Élément base suspendue H.45 P.45 à compléter avec le dessus de la p. 39 • Bases de suspensión A.45 P.45 para terminar con la encimera de la pag.39 • Подвесные основания В.45 П.45 добавить топ со стр.39

Di serie con apertura PushPull. Con maniglia su frontale + 36 € cad. - Con guide ad estrazione totale + 30 € cad.

Standard with PushPull opening - With handle + 36€ each one - With full extension slides + 30€ each
Ouverture standard pousse-lâche - Avec poignée +36 € chaque - Avec coulisses pleine extension + 30€ chaque
De serie con apertura PushPull - Con tirador + 36€ cad. - Con deslizadores de extension total + 30€ cad.
Стандартное открывание PushPull - С ручкой на фасаде + 36 €/шт. - С направляющими полного выдвижения +30 €/шт.

Scocca - Carcass - Structure - Estructura - Каркас

Basic wood
Basic wood
Basic wood
Basic wood
Basic wood

Frassino-Laccato opaco
Ash wood-Matt lacquered
Frêne-laqué mat
Madera de fresno-lacado mate
Ясень-Лак матовый

Laccato lucido
Gloss lacquered
Laqué brillant
Lacado brillo
Лак глянец

L. 45

1 cassettoni

1 big-drawer • 1 gros tiroir • 1 cajon grande • 1 глубокий ящик

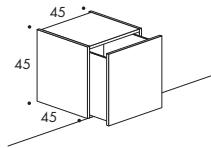

m³ 0,116

Frontale - Front - Façade - Frente - Фасад

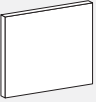
	SMAIL	SMB31310	Basic wood Basic wood • Basic wood • Basic wood • Basic wood	241	262	287
			Frassino-Laccato opaco Ash wood-Matt lacquered • Frêne-laqué mat Madera de fresno-lacado mate • Ясень-Лак матовый	268	289	314
			Laccato lucido Gloss lacquered • Laqué brillant • Lacado brillo • Лак глянец	288	309	334

L. 60

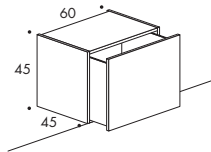

1 cassettoni

1 big-drawer • 1 gros tiroir • 1 cajon grande • 1 глубокий ящик

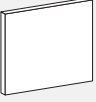

m³ 0,153

Frontale - Front - Façade - Frente - Фасад

	SMAIL	SMB31320	Basic wood Basic wood • Basic wood • Basic wood • Basic wood	255	273	297
			Frassino-Laccato opaco Ash wood-Matt lacquered • Frêne-laqué mat Madera de fresno-lacado mate • Ясень-Лак матовый	293	311	335
			Laccato lucido Gloss lacquered • Laqué brillant • Lacado brillo • Лак глянец	319	337	361
	LIDO	SMB32320	Frassino Ash-wood • Frêne • Madera de fresno • Ясень	501	519	543

L. 90

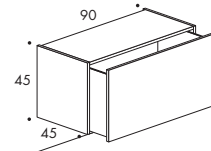

1 cassettoni

1 big-drawer • 1 gros tiroir • 1 cajon grande • 1 глубокий ящик

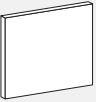

m³ 0,225

Frontale - Front - Façade - Frente - Фасад

	SMAIL	SMB31330	Basic wood Basic wood • Basic wood • Basic wood • Basic wood	289	300	325
			Frassino-Laccato opaco Ash wood-Matt lacquered • Frêne-laqué mat Madera de fresno-lacado mate • Ясень-Лак матовый	346	357	382
			Laccato lucido Gloss lacquered • Laqué brillant • Lacado brillo • Лак глянец	385	396	421
	LIDO	SMB32330	Frassino Ash-wood • Frêne • Madera de fresno • Ясень	623	634	659

Basi sospese H.45 P.45 da completare con top di pag. 39

Suspended base units H.45 D.45 to complete with top of pag.39 • Élément base suspendue H.45 P.45 à compléter avec le dessus de la p. 39 • Bases de suspensión A.45 P.45 para terminar con la encimera de la pag.39 • Подвесные основания В.45 П.45 дообавить топ со стр.39

**Di serie con apertura PushPull.
Con maniglia su frontale + 36 € cad. - Con guide ad estrazione totale + 30 € cad.**

Standard with PushPull opening - With handle + 36€ each one - With full extension slides + 30€ each
Ouverture standard pousse-lâche - Avec poignée +36 € chaque - Avec coulisses pleine extension + 30€ chaque
De serie con abertura PushPull - Con tirador + 36€ cad. - Con deslizadores de extension total + 30€ cad.
Стандартное открывание PushPull - С ручкой на фасаде + 36 €/шт. - С направляющими полного выдвижения +30 €/шт.

Socca - Carcass - Structure - Estructura - Каркас

Basic wood
Basic wood
Basic wood
Basic wood

Frassino-Laccato opaco
Ash wood-Matt lacquered
Frêne-laqué mat
Madera de fresno-lacado mate
Ясень-Лак матовый

Laccato lucido
Gloss lacquered
Laqué brillant
Lacado brillo
Лак глянец

L. 120

1 cassettone
1 big-drawer • 1 gros tiroir • 1 cajon grande • 1 глубокий ящик

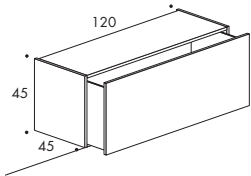

m³ 0,298

Frontale - Front - Façade - Frente - Фасад

	SMAIL	SMB31340	Basic wood Basic wood • Basic wood • Basic wood • Basic wood	336	343	367
			Frassino-Laccato opaco Ash wood-Matt lacquered • Frêne-laqué mat Madera de fresno-lacado mate • Ясень-Лак матовый	412	419	443
			Laccato lucido Gloss lacquered • Laqué brillant • Lacado brillo • Лак глянец	466	473	497
	LIDO	SMB32340	Frassino Ash-wood • Frêne • Madera de fresno • Ясень	771	778	802

L. 150

1 cassettone (internamente diviso 90+60) •
1 big-drawer (internally 90+60) • 1 gros tiroir (divisé intérieurement en 90+60) • 1 cajon grande (interior 90+60) • 1 глубокий ящик (разделён внутри 90+60)

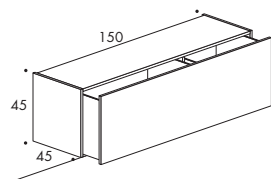

m³ 0,370

Frontale - Front - Façade - Frente - Фасад

	SMAIL	SMB31350	Basic wood Basic wood • Basic wood • Basic wood • Basic wood	400	402	447
			Frassino-Laccato opaco Ash wood-Matt lacquered • Frêne-laqué mat Madera de fresno-lacado mate • Ясень-Лак матовый	494	496	541
			Laccato lucido Gloss lacquered • Laqué brillant • Lacado brillo • Лак глянец	562	564	609
	LIDO	SMB32350	Frassino Ash-wood • Frêne • Madera de fresno • Ясень	921	923	968

Basi sospese H.60 P.45 da completare con top di pag. 39

Suspended base units H.60 D.45 to complete with top of pag.39 • Élément base suspendue H.60 P.45 à compléter avec le dessus de la p. 39 • Bases de suspensión A.60 P.45 para terminar con la encimera de la pag.39 • Подвесные основание В.60 Г.45 дообвить топ со стр.39

Di serie con apertura PushPull. Con maniglia su frontale + 36 € cad.

Standard with PushPull opening - With handle + 36€ each one
Ouverture standard pousse-lâche - Avec poignée +36 € chaque
De serie con abertura PushPull - Con tirador + 36€ cad.

Стандартное открывание PushPull - С ручкой на фасаде + 36 €/шт.

Scocca - Carcass - Structure - Estructura - Каркас

Basic wood
Basic wood
Basic wood
Basic wood

Frassino-Laccato opaco
Ash wood-Matt lacquered
Frêne-laqué mat
Madera de fresno-lacado mate
Ясень-Лак матовый

Laccato lucido
Gloss lacquered
Laqué brillant
Lacado brillo
Лак глянец

L. 45

1 anta, con 1 ripiano legno

1 door, with 1 wooden shelf • 1 porte avec 1 étagère bois • 1 puerta, con 1 estante de madera

1 дверка, с 1 деревянной полкой

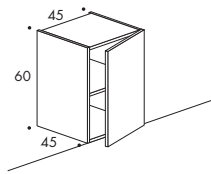

Dx



Sx



m³ 0,153

Frontale - Front - Façade - Frente - Фасад

	SMAIL	Dx SMB31411	Basic wood Basic wood • Basic wood • Basic wood • Basic wood	260	284	317
		Sx SMB31412	Frassino-Laccato opaco Ash wood-Matt lacquered • Frêne-laqué mat Madera de fresno-lacado mate • Ясень-Лак матовый	297	321	354
	LIDO	Dx SMB32411	Frassino Ash-wood • Frêne • Madera de fresno • Ясень	505	529	562
		Sx SMB32412	Laccato lucido Gloss lacquered • Laqué brillant • Lacado brillo • Лак глянец	323	347	380
	SYMPHONIA	Dx SMB34411	Frassino Ash-wood • Frêne • Madera de fresno • Ясень	433	457	490
		Sx SMB34412				

L. 60

1 anta, con 1 ripiano legno

1 door, with 1 wooden shelf • 1 porte avec 1 étagère bois • 1 puerta, con 1 estante de madera

1 дверка, с 1 деревянной полкой

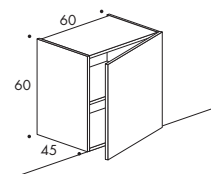

Dx





Sx

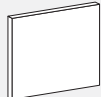

m³ 0,200

Frontale - Front - Façade - Frente - Фасад

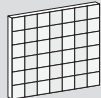
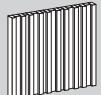
	SMAIL	Dx SMB31421	Basic wood Basic wood • Basic wood • Basic wood • Basic wood	275	295	327
		Sx SMB31422	Frassino-Laccato opaco Ash wood-Matt lacquered • Frêne-laqué mat Madera de fresno-lacado mate • Ясень-Лак матовый	325	345	377
	GENESIS No pushpull No pushpull • No pousse-lâche No pushpull • Не может быть push-pull	Dx SMB33421	Frassino-Laccato opaco Ash wood-matt lacquered • Frêne-laqué mat Madera de fresno-lacado mate • Ясень-Лак матовый	422	442	474
		Sx SMB33422				
	LIDO	Dx SMB32421	Frassino Ash-wood • Frêne • Madera de fresno • Ясень	586	606	638
		Sx SMB32422				
	SYMPHONIA	Dx SMB34421	Frassino Ash-wood • Frêne • Madera de fresno • Ясень	544	564	596
		Sx SMB34422				

Basi sospese H.60 P.45 da completare con top di pag. 39

Suspended base units H.60 D.45 to complete with top of pag.39 • Élément base suspendue H.60 P.45 à compléter avec le dessus de la p. 39 • Bases de suspensión A.60 P.45 para terminar con la encimera de la pag.39 • Подвесные основание H.60 P.45 добавить топ со стр. 39

Di serie con apertura PushPull. Con maniglia su frontale + 36 € cad.

Standard with PushPull opening - With handle + 36€ each one
Ouverture standard pousse-lâche - Avec poignée +36 € chaque
De serie con abertura PushPull - Con tirador + 36€ cad.

Стандартное открывание PushPull - С ручкой на фасаде + 36 €/шт.

Socca - Carcass - Structure - Estructura - Каркас

Basic wood
Basic wood
Basic wood
Basic wood
Basic wood

Frassino-Laccato opaco
Ash wood-Matt lacquered
Frêne-laqué mat
Madera de fresno-lacado mate
Ясень-Лак матовый

Laccato lucido
Gloss lacquered
Laqué brillant
Lacado brillo
Лак глянец

L. 90

2 ante, con 1 ripiano legno

2 doors, with 1 wooden shelf • 2 portes avec 1 étagère bois • 2 puertas, con 1 estante de madera

2 дверки, с 1 деревянной полкой

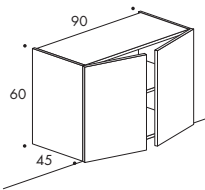

m³ 0,295

Frontale - Front - Façade - Frente - Фасад

	SMAIL	SMB31430	Basic wood Basic wood • Basic wood • Basic wood • Basic wood	357	368	402
			Frassino-Laccato opaco Ash wood-Matt lacquered • Frêne-laqué mat Madera de fresno-lacado mate • Ясень-Лак матовый	431	442	476
			Laccato lucido Gloss lacquered • Laqué brillant • Lacado brillo • Лак глянец	483	494	528
	LIDO	SMB32430	Frassino Ash-wood • Frêne • Madera de fresno • Ясень	847	858	892
	SYMPHONIA	SMB34430	Frassino Ash-wood • Frêne • Madera de fresno • Ясень	703	714	748

L. 120

2 ante, con 1 ripiano legno

2 doors, with 1 wooden shelf • 2 portes avec 1 étagère bois • 2 puertas, con 1 estante de madera

2 дверки, с 1 деревянной полкой

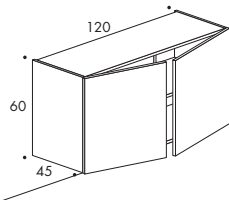

m³ 0,390

Frontale - Front - Façade - Frente - Фасад

	SMAIL	SMB31440	Basic wood Basic wood • Basic wood • Basic wood • Basic wood	416	421	454
			Frassino-Laccato opaco Ash wood-Matt lacquered • Frêne-laqué mat Madera de fresno-lacado mate • Ясень-Лак матовый	516	521	554
			Laccato lucido Gloss lacquered • Laqué brillant • Lacado brillo • Лак глянец	588	593	626
	GENESIS No pushpull No pushpull • No pousse-lâche No pushpull • Не может быть push-pull	SMB33440	Frassino-Laccato opaco Ash wood-matt lacquered • Frêne-laqué mat Madera de fresno-lacado mate • Ясень-Лак матовый	710	715	748
	LIDO	SMB32440	Frassino Ash-wood • Frêne • Madera de fresno • Ясень	1.038	1.043	1.076
	SYMPHONIA	SMB34440	Frassino Ash-wood • Frêne • Madera de fresno • Ясень	954	959	992

Basi sospese H.90 P.45 da completare con top di pag. 39

Suspended base units H.90 D.45 to complete with top of pag.39 • Élément base suspendue H.90 P.45 à compléter avec le dessus de la p. 39 • Bases de suspensión A.90 P.45 para terminar con la encimera de la pag.39 • Подвесные основания В.90 Г.45 добавить топ со стр.39

Di serie con apertura PushPull. Con maniglia su frontale + 36 € cad.

Standard with PushPull opening - With handle + 36€ each one
Ouverture standard pousse-lâche - Avec poignée +36 € chaque
De serie con abertura PushPull - Con tirador + 36€ cad.

Стандартное открывание PushPull - С ручкой на фасаде + 36 €/шт.

Scocca - Carcass - Structure - Estructura - Каркас

Basic wood
Basic wood
Basic wood
Basic wood

Frassino-Laccato opaco
Ash wood-Matt lacquered
Frêne-laqué mat
Madera de fresno-lacado mate
Ясень-Лак матовый

Laccato lucido
Gloss lacquered
Laqué brillant
Lacado brillo
Лак глянец

L. 45

1 anta, con 1 ripiano legno

1 door, with 1 wooden shelf • 1 porte avec 1 étagère bois • 1 puerta, con 1 estante de madera

1 дверка, с 1 деревянной полкой

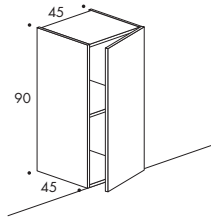

Dx





Sx



m³ 0,225

Frontale - Front - Façade - Frente - Фасад

	SMAIL	Dx SMB31511	Basic wood Basic wood • Basic wood • Basic wood • Basic wood	282	308	339
		Sx SMB31512	Frassino-Laccato opaco Ash wood-Matt lacquered • Frêne-laqué mat Madera de fresno-lacado mate • Ясень-Лак матовый	338	364	395
	LIDO	Dx SMB32511	Frassino Ash-wood • Frêne • Madera de fresno • Ясень	621	647	678
		Sx SMB32512	Laccato lucido Gloss lacquered • Laqué brillant • Lacado brillo • Лак глянец	379	405	436
	SYMPHONIA	Dx SMB34511	Frassino Ash-wood • Frêne • Madera de fresno • Ясень	520	546	577
		Sx SMB34512				

L. 60

1 anta, con 1 ripiano legno

1 door, with 1 wooden shelf • 1 porte avec 1 étagère bois • 1 puerta, con 1 estante de madera

1 дверка, с 1 деревянной полкой

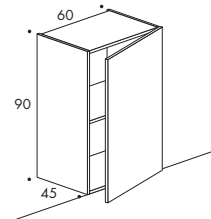

Dx





Sx



m³ 0,295

Frontale - Front - Façade - Frente - Фасад

	SMAIL	Dx SMB31521	Basic wood Basic wood • Basic wood • Basic wood • Basic wood	307	342	385
		Sx SMB31522	Frassino-Laccato opaco Ash wood-Matt lacquered • Frêne-laqué mat Madera de fresno-lacado mate • Ясень-Лак матовый	383	418	461
	LIDO	Dx SMB32521	Frassino Ash-wood • Frêne • Madera de fresno • Ясень	762	797	840
		Sx SMB32522	Laccato lucido Gloss lacquered • Laqué brillant • Lacado brillo • Лак глянец	437	472	515
	SYMPHONIA	Dx SMB34521	Frassino Ash-wood • Frêne • Madera de fresno • Ясень	669	704	747
		Sx SMB34522				

Top basi P.45

Top base units d.45 • Dessus bases P.45 • Top bases p.45 • Столешница основания Г.45

	L.	Cod.	m ²	Finitura - Finish - Finition - Finitura - Отделка		
				Basic wood Basic wood Basic wood Basic wood	Frassino-Laccato opaco Ash wood-Matt lacquered Frêne-laqué mat Madera de fresno-lacado mate Ясень-Лак матовый	Laccato lucido Gloss lacquered Laqué brillant Lacado brillo Лак глянец

Sp. 1,8

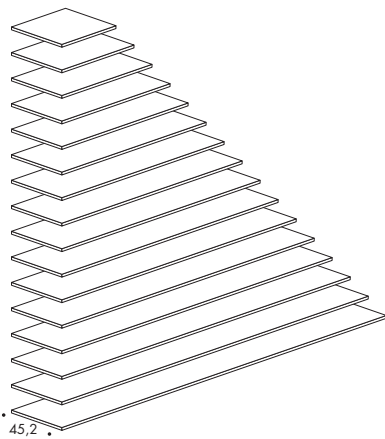

45	SMBT0110	0,005	51	63	84
60	SMBT0115	0,006	53	68	96
75	SMBT0120	0,007	55	74	108
90	SMBT0125	0,009	58	80	120
105	SMBT0130	0,010	63	90	138
120	SMBT0135	0,012	68	101	156
135	SMBT0140	0,013	72	109	171
150	SMBT0145	0,015	76	117	187
165	SMBT0150	0,016	80	126	202
180	SMBT0155	0,018	84	134	218
195	SMBT0160	0,019	89	143	233
210	SMBT0165	0,020	94	151	248
225	SMBT0170	0,022	98	160	264
240	SMBT0175	0,023	101	167	278
255	SMBT0180	0,025	105	175	293
270	SMBT0185	0,026	108	182	307

Basi
Floor-base units
P. 45

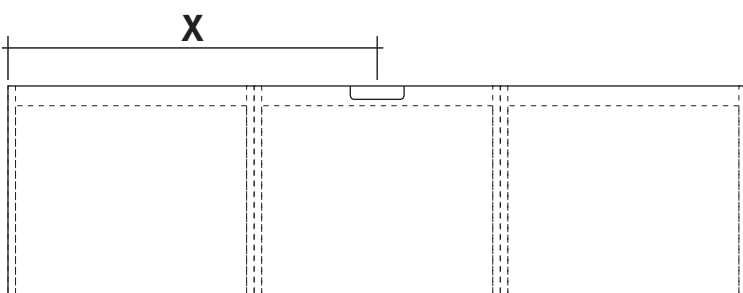

ADDEBITO PASSACAVALI (L. 8 cm. x P. 2 cm.)

47

Indicare la posizione (X)

Surcharge cable glands (L.8cmxD.2cm)

Specify position (X)

Supplément découpe passage de câbles (L.8 cm x P.2 cm)

Indiquer la position (X)

Coste para guiacabos (L.8cmxP.2cm)

Indicar la posición (X)

НАЦЕНКА ЗА ОТВЕРСТИЯ ПОД КАБЕЛЪ (Д. 8 см. х ГЛ. 2 см.)

Указать расположение (X)

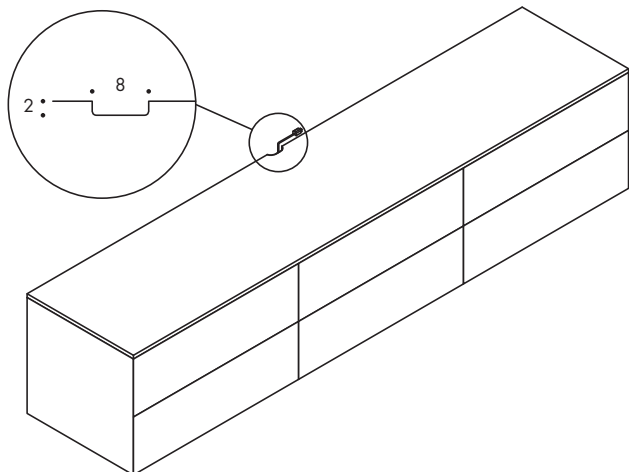

Pensili P.35

Wall-hung unit D.35 • Élément mural P.35 • Colgante P.35 • Навесные шкафчики Гл.35

Modularità pensili

Wall-hung modularity • Modularité éléments muraux
Modularidad colgantes • Модульность навесных шкафчиков

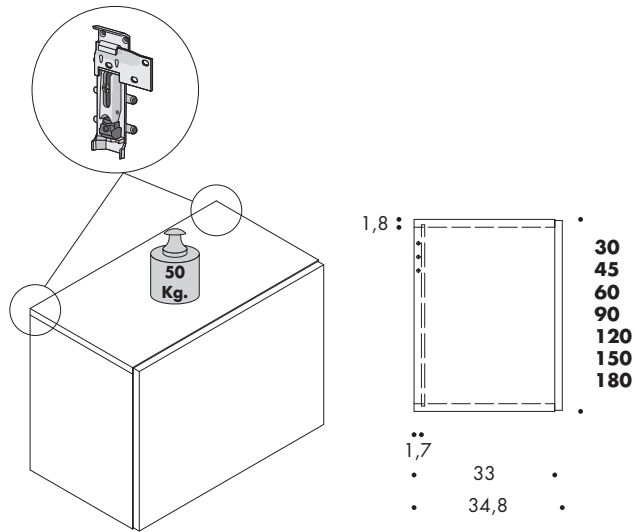

Portata massima 50kg uniformemente distribuiti (compreso il peso del mobile)
Maximum capacity 50kg evenly distributed (including the weight of the cabinet)
50 kg de capacitate maximale repartite uniformément (y compris le poids de l'armoire)
50kg máxima capacidad distribuida de manera uniforme (incluyendo el peso del armario)
Макс. нагрузка 50 кг равномерно распределённых (вместе с весом модуля)

Posizione maniglia

Handle position • Position poignée
Posicion del tirador • Расположение ручки

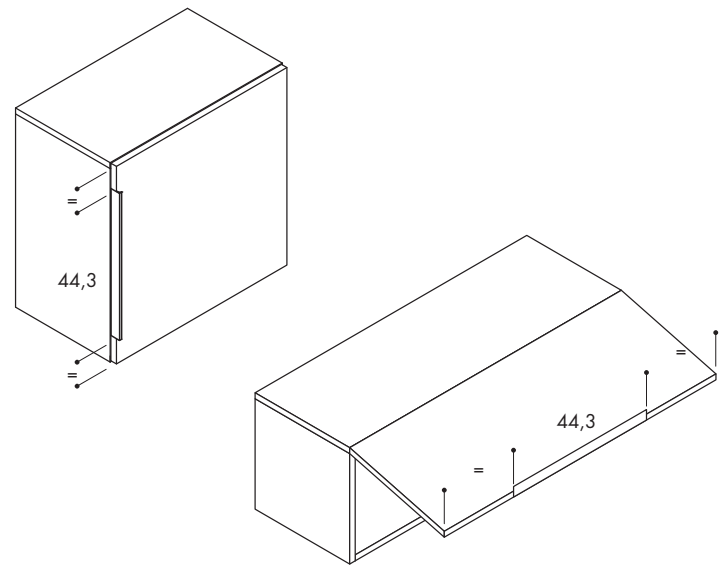

Modularità pensili

Wall-hung modularity • Modularité éléments muraux • Modularidad colgantes • Модульность навесных шкафчиков

	L. 30	L. 45	L. 60	L. 90	L. 120	L. 150
H. 30						
Frontale Front Façade Frente Фасада				SMAIL	SMAIL	SMAIL
				LIDO	LIDO	LIDO
H. 45						
Frontale Front Façade Frente Фасада				SMAIL	SMAIL	
				LIDO	LIDO	
H. 45						
Frontale Front Façade Frente Фасада		SMAIL	SMAIL	SMAIL	SMAIL	
			LIDO		LIDO	

Pensili P.35

Wall-hung unit D.35 • Élément mural P.35 • Colgante P.35 • Навесные шкафчики П.35

	L. 30	L. 45	L. 60	L. 90	L. 120	
H. 60						
Frontale Front Façade Frente Фасада		SMAIL	SMAIL	SMAIL	SMAIL	SMAIL
			GENESIS		GENESIS	
		LIDO	LIDO	LIDO	LIDO	LIDO
		SYMPHONIA	SYMPHONIA	SYMPHONIA	SYMPHONIA	
H. 90						
Frontale Front Façade Frente Фасада		SMAIL	SMAIL	SMAIL	* SMAIL	SMAIL
						* SMAIL
		LIDO	LIDO	LIDO		LIDO
		SYMPHONIA	SYMPHONIA	SYMPHONIA		SYMPHONIA
H. 120						
Frontale Front Façade Frente Фасада	SMAIL	SMAIL	SMAIL	* SMAIL	SMAIL	
				* GENESIS		
	SYMPHONIA	SYMPHONIA	SYMPHONIA	* SYMPHONIA	SYMPHONIA	
H. 150						
Frontale Front Façade Frente Фасада	SMAIL	SMAIL	SMAIL			
H. 180						
Frontale Front Façade Frente Фасада	SMAIL	SMAIL	SMAIL			
	SYMPHONIA	SYMPHONIA	SYMPHONIA			

Ribalta H.30 P.35

Flap-door unit H.30 D.35 • Élément porte relevable H.30 P.35 • Tara abatible A.30 P.35 • Откидная дверка В.30 Г.35

Di serie con apertura PushPull. Con maniglia su frontale + 36 € cad.

Standard with PushPull opening - With handle + 36€ each one -

Ouverture standard pousse-lâche - Avec poignée +36 € chaque -

De serie con abertura PushPull - Con tirador + 36€ cad. -

Стандартное открывание PushPull - С ручкой на фасаде + 36 €/шт. -

Scocca - Carcass - Structure - Estructura - Каркас

Basic wood
Basic wood
Basic wood
Basic wood
Basic wood

Frassino-Laccato opaco
Ash wood-Matt lacquered
Frêne-laqué mat
Madera de fresno-lacado mate
Ясень-Лак матовый

Laccato lucido
Gloss lacquered
Laqué brillant
Lacado brillo
Лак глянец

L. 90

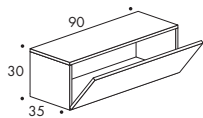

1 anta

1 door • 1 porte • 1 puerta • 1 дверь

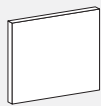

m³ 0,123

Frontale - Front - Façade - Frente - Фасад

	SMAIL	SMBR1232	Basic wood Basic wood • Basic wood • Basic wood • Basic wood	276	327	377
			Frassino-Laccato opaco Ash wood-Matt lacquered • Frêne-laqué mat Madera de fresno-lacado mate • Ясень-Лак матовый	332	383	433
			Laccato lucido Gloss lacquered • Laqué brillant • Lacado brillo • Лак глянец	373	424	474
	LIDO	SMBR2232	Frassino Ash-wood • Frêne • Madera de fresno • Ясень	514	565	615

L. 120

1 anta

1 door • 1 porte • 1 puerta • 1 дверь

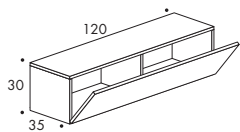

m³ 0,162

Frontale - Front - Façade - Frente - Фасад

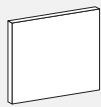
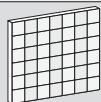
	SMAIL	SMBR1242	Basic wood Basic wood • Basic wood • Basic wood • Basic wood	322	384	448
			Frassino-Laccato opaco Ash wood-Matt lacquered • Frêne-laqué mat Madera de fresno-lacado mate • Ясень-Лак матовый	378	440	504
			Laccato lucido Gloss lacquered • Laqué brillant • Lacado brillo • Лак глянец	418	480	544
	LIDO	SMBR2242	Frassino Ash-wood • Frêne • Madera de fresno • Ясень	634	696	760

L. 150

1 anta

1 door • 1 porte • 1 puerta • 1 дверь

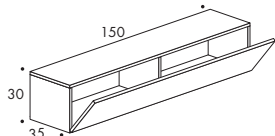

m³ 0,202

Frontale - Front - Façade - Frente - Фасад

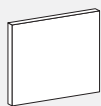
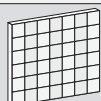
	SMAIL	SMBR1252	Basic wood Basic wood • Basic wood • Basic wood • Basic wood	369	443	519
			Frassino-Laccato opaco Ash wood-Matt lacquered • Frêne-laqué mat Madera de fresno-lacado mate • Ясень-Лак матовый	426	500	576
			Laccato lucido Gloss lacquered • Laqué brillant • Lacado brillo • Лак глянец	466	540	616
	LIDO	SMBR2252	Frassino Ash-wood • Frêne • Madera de fresno • Ясень	729	803	879

Ribalta H.45 P.35 e mobile bar

Flap-door unit H.45 D.35 and bar unit • Élément porte relevable H.45 P.35 et meuble bar • Tapa abatible A.45 P.35 y mueble bar • Откидная дверка В.45 Г.35 и модуль для бара

Di serie con apertura PushPull. Con maniglia su frontale + 36 € cad.

Standard with PushPull opening - With handle + 36€ each one -

Ouverture standard pousse-lâche - Avec poignée +36 € chaque -

De serie con abertura PushPull - Con tirador + 36€ cad. -

Стандартное открывание PushPull - С ручкой на фасаде + 36 €/шт. -

Socca - Carcass - Structure - Estructura - Каркас

Basic wood
Basic wood
Basic wood
Basic wood
Basic wood

Frassino-Laccato opaco
Ash wood-Matt lacquered
Frêne-laqué mat
Madera de fresno-lacado mate
Ясень-Лак матовый

Laccato lucido
Gloss lacquered
Laqué brillant
Lacado brillo
Лак глянец

L. 90

1 anta

1 door • 1 porte • 1 puerta • 1 дверь

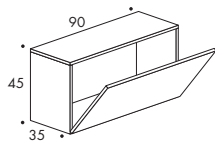

m³ 0,178

Frontale - Front - Façade - Frente - Фасад

	SMAIL	SMBR1332	Basic wood Basic wood • Basic wood • Basic wood • Basic wood	292	348	399
			Frassino-Laccato opaco Ash wood-Matt lacquered • Frêne-laqué mat Madera de fresno-lacado mate • Ясень-Лак матовый	348	404	455
			Laccato lucido Gloss lacquered • Laqué brillant • Lacado brillo • Лак глянец	388	444	495
	LIDO	SMBR2332	Frassino Ash-wood • Frêne • Madera de fresno • Ясень	630	686	737

L. 120

1 anta

1 door • 1 porte • 1 puerta • 1 дверь

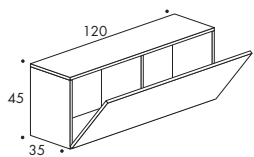

m³ 0,236

Frontale - Front - Façade - Frente - Фасад

	SMAIL	SMBR1342	Basic wood Basic wood • Basic wood • Basic wood • Basic wood	342	410	474
			Frassino-Laccato opaco Ash wood-Matt lacquered • Frêne-laqué mat Madera de fresno-lacado mate • Ясень-Лак матовый	398	466	530
			Laccato lucido Gloss lacquered • Laqué brillant • Lacado brillo • Лак глянец	439	507	571
	LIDO	SMBR2342	Frassino Ash-wood • Frêne • Madera de fresno • Ясень	791	859	923

L. 120

Mobile Bar L.120 H.60 P.35

Bar unit L.120 H.60 P.35 • Meuble bar L.120 H.60 P.35 • Mueble bar L.120 A.60 P.35

Модуль для бара Ш.120 В.60 Г.35

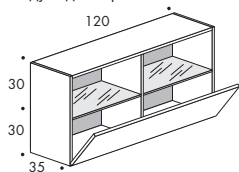

m³ 0,318

Frontale - Front - Façade - Frente - Фасад

	SMAIL	SMBR1442	Basic wood Basic wood • Basic wood • Basic wood • Basic wood	428	699	907
			Frassino-Laccato opaco Ash wood-Matt lacquered • Frêne-laqué mat Madera de fresno-lacado mate • Ясень-Лак матовый	484	755	963
			Laccato lucido Gloss lacquered • Laqué brillant • Lacado brillo • Лак глянец	524	795	1.003
	LIDO	SMBR2442	Frassino Ash-wood • Frêne • Madera de fresno • Ясень	720	991	1.199

Ribalta H.30 P.35

Flap-door unit H.30 D.35 • Élément porte relevable H.30 P.35 • Tara abatible A.30 P.35 • Откидная дверка В.30 Г.35

Di serie con apertura PushPull. Con maniglia su frontale + 36 € cad.

Standard with PushPull opening - With handle + 36€ each one -
Ouverture standard pousse-lâche - Avec poignée +36 € chaque -
De serie con abertura PushPull - Con tirador + 36€ cad. -
Стандартное открывание PushPull - С ручкой на фасаде + 36 €/шт. -

Scocca - Carcass - Structure - Estructura - Каркас

Basic wood
Basic wood
Basic wood
Basic wood
Basic wood

Frassino-Laccato opaco
Ash wood-Matt lacquered
Frêne-laqué mat
Madera de fresno-lacado mate
Ясень-Лак матовый

Laccato lucido
Gloss lacquered
Laqué brillant
Lacado brillo
Лак глянец

L. 90

1 anta

1 door • 1 porte • 1 puerta • 1 дверь

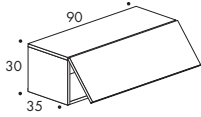

m³ 0,123

Frontale - Front - Façade - Frente - Фасад

	SMAIL	SMBR1231	Basic wood Basic wood • Basic wood • Basic wood • Basic wood	276	327	377
			Frassino-Laccato opaco Ash wood-Matt lacquered • Frêne-laqué mat Madera de fresno-lacado mate • Ясень-Лак матовый	332	383	433
			Laccato lucido Gloss lacquered • Laqué brillant • Lacado brillo • Лак глянец	373	424	474
	LIDO	SMBR2231	Frassino Ash-wood • Frêne • Madera de fresno • Ясень	514	565	615

L. 120

1 anta

1 door • 1 porte • 1 puerta • 1 дверь

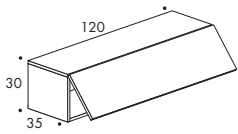

m³ 0,162

Frontale - Front - Façade - Frente - Фасад

	SMAIL	SMBR1241	Basic wood Basic wood • Basic wood • Basic wood • Basic wood	322	384	448
			Frassino-Laccato opaco Ash wood-Matt lacquered • Frêne-laqué mat Madera de fresno-lacado mate • Ясень-Лак матовый	378	440	504
			Laccato lucido Gloss lacquered • Laqué brillant • Lacado brillo • Лак глянец	418	480	544
	LIDO	SMBR2241	Frassino Ash-wood • Frêne • Madera de fresno • Ясень	634	696	760

L. 150

1 anta

1 door • 1 porte • 1 puerta • 1 дверь

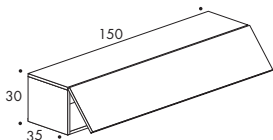

m³ 0,202

Frontale - Front - Façade - Frente - Фасад

	SMAIL	SMBR1251	Basic wood Basic wood • Basic wood • Basic wood • Basic wood	369	443	519
			Frassino-Laccato opaco Ash wood-Matt lacquered • Frêne-laqué mat Madera de fresno-lacado mate • Ясень-Лак матовый	426	500	576
			Laccato lucido Gloss lacquered • Laqué brillant • Lacado brillo • Лак глянец	466	540	616
	LIDO	SMBR2251	Frassino Ash-wood • Frêne • Madera de fresno • Ясень	729	803	879

Ribalta H.45 P.35

Flap-door unit H.45 D.35 • Élément porte relevable H.45 P.35 • Tapa abatible A.45 P.35 • Откидная дверка В.45 Г.35

Di serie con apertura PushPull. Con maniglia su frontale + 36 € cad.

Standard with PushPull opening - With handle + 36€ each one -

Ouverture standard pousse-lâche - Avec poignée +36 € chaque -

De serie con abertura PushPull - Con tirador + 36€ cad. -

Стандартное открывание PushPull - С ручкой на фасаде + 36 €/шт. -

Socca - Carcass - Structure - Estructura - Каркас

Basic wood
Basic wood
Basic wood
Basic wood
Basic wood

Frassino-Laccato opaco
Ash wood-Matt lacquered
Frêne-laqué mat
Madera de fresno-lacado mate
Ясень-Лак матовый

Laccato lucido
Gloss lacquered
Laqué brillant
Lacado brillo
Лак глянец

L. 90

1 anta

1 door • 1 porte • 1 puerta • 1 дверь

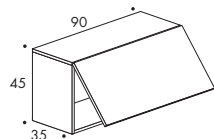

m³ 0,178

Frontale - Front - Façade - Frente - Фасад

	SMAIL	SMBR1331	Basic wood Basic wood • Basic wood • Basic wood • Basic wood	292	348	399
			Frassino-Laccato opaco Ash wood-Matt lacquered • Frêne-laqué mat Madera de fresno-lacado mate • Ясень-Лак матовый	348	404	455
			Laccato lucido Gloss lacquered • Laqué brillant • Lacado brillo • Лак глянец	388	444	495
	LIDO	SMBR2331	Frassino Ash-wood • Frêne • Madera de fresno • Ясень	630	686	737

L. 120

1 anta

1 door • 1 porte • 1 puerta • 1 дверь

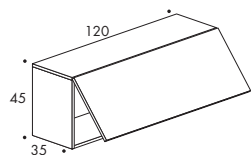

m³ 0,236

Frontale - Front - Façade - Frente - Фасад

	SMAIL	SMBR1341	Basic wood Basic wood • Basic wood • Basic wood • Basic wood	342	410	474
			Frassino-Laccato opaco Ash wood-Matt lacquered • Frêne-laqué mat Madera de fresno-lacado mate • Ясень-Лак матовый	398	466	530
			Laccato lucido Gloss lacquered • Laqué brillant • Lacado brillo • Лак глянец	439	507	571
	LIDO	SMBR2341	Frassino Ash-wood • Frêne • Madera de fresno • Ясень	791	859	923

Pensile H.45 P.35

Wall-hung unit H.45 D.35 • Élément mural H.45 P.35 • Colgante A.45 P.35 • Навесной шкафчик В.45 Г.35

Di serie con apertura PushPull. Con maniglia su frontale + 36 € cad.

Standard with PushPull opening - With handle + 36€ each one -

Ouverture standard pousse-lâche - Avec poignée +36 € chaque -

De serie con abertura PushPull - Con tirador + 36€ cad. -

Стандартное открывание PushPull - С ручкой на фасаде + 36 €/шт. -

Scocca - Carcass - Structure - Estructura - Каркас

Basic wood
Basic wood
Basic wood
Basic wood
Basic wood

Frassino-Laccato opaco
Ash wood-Matt lacquered
Frêne-laqué mat
Madera de fresno-lacado mate
Ясень-Лак матовый

Laccato lucido
Gloss lacquered
Laqué brillant
Lacado brillo
Лак глянец

L. 45

1 ante

1 door • 1 porte • 1 puerta • 1 дверь

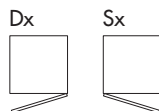
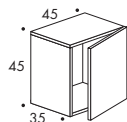

m³ 0,092

Frontale - Front - Façade - Frente - Фасад

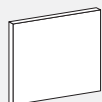
 SMAIL	Dx SMBP1311	Basic wood Basic wood • Basic wood • Basic wood • Basic wood	209	247	286
	Sx SMBP1312	Frassino-Laccato opaco Ash wood-Matt lacquered • Frêne-laqué mat Madera de fresno-lacado mate • Ясень-Лак матовый	237	275	314
		Laccato lucido Gloss lacquered • Laqué brillant • Lacado brillo • Лак глянец	257	295	334

L. 60

1 ante

1 door • 1 porte • 1 puerta • 1 дверь

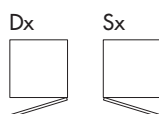
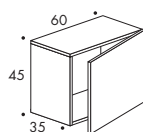

m³ 0,121

Frontale - Front - Façade - Frente - Фасад

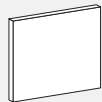
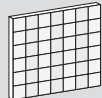
 SMAIL	Dx SMBP1321	Basic wood Basic wood • Basic wood • Basic wood • Basic wood	219	264	310
	Sx SMBP1322	Frassino-Laccato opaco Ash wood-Matt lacquered • Frêne-laqué mat Madera de fresno-lacado mate • Ясень-Лак матовый	256	301	347
		Laccato lucido Gloss lacquered • Laqué brillant • Lacado brillo • Лак глянец	282	327	373
 LIDO	Dx SMBP2321	Frassino Ash-wood • Frêne • Madera de fresno • Ясень	464	509	555
	Sx SMBP2322				

L. 90

2 ante

2 doors • 2 portes • 2 puertas • 2 двери

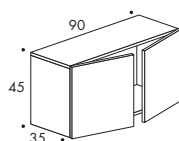

m³ 0,178

Frontale - Front - Façade - Frente - Фасад

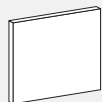
 SMAIL	SMBP1330	Basic wood Basic wood • Basic wood • Basic wood • Basic wood	284	340	397
		Frassino-Laccato opaco Ash wood-Matt lacquered • Frêne-laqué mat Madera de fresno-lacado mate • Ясень-Лак матовый	340	396	453
		Laccato lucido Gloss lacquered • Laqué brillant • Lacado brillo • Лак глянец	380	436	493

Pensile H.45 P.35

Wall-hung unit H.45 D.35 • Élément mural H.45 P.35 • Colgante A.45 P.35 • Навесной шкафчик В.45 Г.35

Di serie con apertura PushPull. Con maniglia su frontale + 36 € cad.

Standard with PushPull opening - With handle + 36€ each one -

Ouverture standard pousse-lâche - Avec poignée +36 € chaque -

De serie con abertura PushPull - Con tirador + 36€ cad. -

Стандартное открывание PushPull - С ручкой на фасаде + 36 €/шт. -

Scocca - Carcass - Structure - Estructura - Каркас

Basic wood
Basic wood
Basic wood
Basic wood
Basic wood

Frassino-Laccato opaco
Ash wood-Matt lacquered
Frêne-laqué mat
Madera de fresno-lacado mate
Ясень-Лак матовый

Laccato lucido
Gloss lacquered
Laqué brillant
Lacado brillo
Лак глянец

L. 120

2 ante

2 doors • 2 portes • 2 puertas • 2 двери

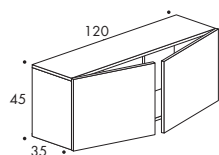

m³ 0,236

Frontale - Front - Façade - Frente - Фасад

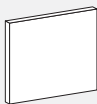
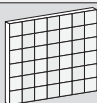
 SMAIL	SMBP1340	Basic wood Basic wood • Basic wood • Basic wood • Basic wood	336	404	475
		Frassino-Laccato opaco Ash wood-Matt lacquered • Frêne-laqué mat Madera de fresno-lacado mate • Ясень-Лак матовый	410	478	549
		Laccato lucido Gloss lacquered • Laqué brillant • Lacado brillo • Лак глянец	462	530	601
 LIDO	SMBP2340	Frassino Ash-wood • Frêne • Madera de fresno • Ясень	826	894	965

Pensile H.60 P.35

Wall-hung unit H.60 D.35 • Élément mural H.60 P.35 • Colgante A.60 P.35 • Навесной шкафчик В.60 Г.35

Di serie con apertura PushPull. Con maniglia su frontale + 36 € cad.

Standard with PushPull opening - With handle + 36€ each one
Ouverture standard pousse-lâche - Avec poignée +36 € chaque
De serie con abertura PushPull - Con tirador + 36€ cad.

Стандартное открывание PushPull - С ручкой на фасаде + 36 €/шт.

Scocca - Carcass - Structure - Estructura - Каркас

Basic wood
Basic wood
Basic wood
Basic wood
Basic wood

Frassino-Laccato opaco
Ash wood-Matt lacquered
Frêne-laqué mat
Madera de fresno-lacado mate
Ясень-Лак матовый

Laccato lucido
Gloss lacquered
Laqué brillant
Lacado brillo
Лак глянец

L. 45

1 anta, con 1 ripiano legno

1 door, with 1 wooden shelf • 1 porte avec 1 étagère bois • 1 puerta, con 1 estante de madera

1 дверка, с 1 деревянной полкой

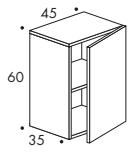

Dx



Sx



m³ 0,121

Frontale - Front - Façade - Frente - Фасад

	SMAIL	Dx SMBP1411	Basic wood Basic wood • Basic wood • Basic wood • Basic wood	237	272	313
		Sx SMBP1412	Frassino-Laccato opaco Ash wood-Matt lacquered • Frêne-laqué mat Madera de fresno-lacado mate • Ясень-Лак матовый	274	309	350
	LIDO	Dx SMBP2411	Frassino Ash-wood • Frêne • Madera de fresno • Ясень	482	517	558
		Sx SMBP2412	Laccato lucido Gloss lacquered • Laqué brillant • Lacado brillo • Лак глянец	300	335	376
	SYMPHONIA	Dx SMBP4411	Frassino Ash-wood • Frêne • Madera de fresno • Ясень	410	445	486
		Sx SMBP4412				

L. 60

1 anta, con 1 ripiano legno

1 door, with 1 wooden shelf • 1 porte avec 1 étagère bois • 1 puerta, con 1 estante de madera

1 дверка, с 1 деревянной полкой

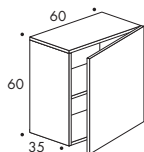

Dx







Sx



m³ 0,159

Frontale - Front - Façade - Frente - Фасад

	SMAIL	Dx SMBP1421	Basic wood Basic wood • Basic wood • Basic wood • Basic wood	251	297	350
		Sx SMBP1422	Frassino-Laccato opaco Ash wood-Matt lacquered • Frêne-laqué mat Madera de fresno-lacado mate • Ясень-Лак матовый	301	347	400
	GENESIS No pushpull No pushpull • No pousse-lâche No pushpull • Не может быть push-pull	Dx SMBP3421	Frassino-Laccato opaco Ash wood-matt lacquered • Frêne-laqué mat Madera de fresno-lacado mate • Ясень-Лак матовый	398	444	497
		Sx SMBP3422				
	LIDO	Dx SMBP2421	Frassino Ash-wood • Frêne • Madera de fresno • Ясень	562	608	661
		Sx SMBP2422				
	SYMPHONIA	Dx SMBP4421	Frassino Ash-wood • Frêne • Madera de fresno • Ясень	520	566	619
		Sx SMBP4422				

Pensile H.60 P.35

Wall-hung unit H.60 D.35 • Élément mural H.60 P.35 • Colgante A.60 P.35 • Навесной шкафчик В.60 Г.35

Di serie con apertura PushPull. Con maniglia su frontale + 36 € cad.

Standard with PushPull opening - With handle + 36€ each one

Ouverture standard pousse-lâche - Avec poignée +36 € chaque

De serie con abertura PushPull - Con tirador + 36€ cad.

Стандартное открывание PushPull - С ручкой на фасаде + 36 €/шт.

Socca - Carcass - Structure - Estructura - Каркас

Basic wood
Basic wood
Basic wood
Basic wood
Basic wood

Frassino-Laccato opaco
Ash wood-Matt lacquered
Frêne-laqué mat
Madera de fresno-lacado mate
Ясень-Лак матовый

Laccato lucido
Gloss lacquered
Laqué brillant
Lacado brillo
Лак глянец

L. 90

2 ante, con 1 ripiano legno

2 doors, with 1 wooden shelf • 2 portes avec 1 étagère bois • 2 puertas, con 1 estante de madera

2 дверки, с 1 деревянной полкой

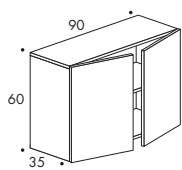

m³ 0,234

Frontale - Front - Façade - Frente - Фасад

	SMAIL	SMBP1430	Basic wood Basic wood • Basic wood • Basic wood • Basic wood	327	387	454
			Frassino-Laccato opaco Ash wood-Matt lacquered • Frêne-laqué mat Madera de fresno-lacado mate • Ясень-Лак матовый	401	461	528
			Laccato lucido Gloss lacquered • Laqué brillant • Lacado brillo • Лак глянец	453	513	580
	LIDO	SMBP2430	Frassino Ash-wood • Frêne • Madera de fresno • Ясень	817	877	944
	SYMPHONIA	SMBP4430	Frassino Ash-wood • Frêne • Madera de fresno • Ясень	673	733	800

L. 120

2 ante, con 1 ripiano legno

2 doors, with 1 wooden shelf • 2 portes avec 1 étagère bois • 2 puertas, con 1 estante de madera

2 дверки, с 1 деревянной полкой

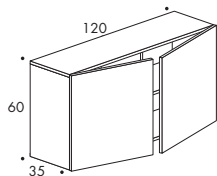

m³ 0,310

Frontale - Front - Façade - Frente - Фасад

	SMAIL	SMBP1440	Basic wood Basic wood • Basic wood • Basic wood • Basic wood	396	454	521
			Frassino-Laccato opaco Ash wood-Matt lacquered • Frêne-laqué mat Madera de fresno-lacado mate • Ясень-Лак матовый	496	554	621
			Laccato lucido Gloss lacquered • Laqué brillant • Lacado brillo • Лак глянец	568	626	693
	GENESIS No pushpull No pushpull • No pousse-lâche No pushpull • Не может быть push-pull	SMBP3440	Frassino-Laccato opaco Ash wood-matt lacquered • Frêne-laqué mat Madera de fresno-lacado mate • Ясень-Лак матовый	690	748	815
	LIDO	SMBP2440	Frassino Ash-wood • Frêne • Madera de fresno • Ясень	1.018	1.076	1.143
	SYMPHONIA	SMBP4440	Frassino Ash-wood • Frêne • Madera de fresno • Ясень	934	992	1.059

Pensile H.90 P.35

Wall-hung unit H.90 D.35 • Élément mural H.90 P.35 • Colgante A.90 P.35 • Навесной шкафчик В.90 Г.35

Di serie con apertura PushPull. Con maniglia su frontale + 36 € cad.

Standard with PushPull opening - With handle + 36€ each one

Ouverture standard pousse-lâche - Avec poignée +36 € chaque

De serie con abertura PushPull - Con tirador + 36€ cad.

Стандартное открывание PushPull - С ручкой на фасаде + 36 €/шт.

Scocca - Carcass - Structure - Estructura - Каркас

Basic wood
Basic wood
Basic wood
Basic wood

Frassino-Laccato opaco
Ash wood-Matt lacquered
Frêne-laqué mat
Madera de fresno-lacado mate
Ясень-Лак матовый

Laccato lucido
Gloss lacquered
Laqué brillant
Lacado brillo
Лак глянец

L. 45

1 anta, con 1 ripiano legno

1 door, with 1 wooden shelf • 1 porte avec 1 étagère bois • 1 puerta, con 1 estante de madera

1 дверка, с 1 деревянной полкой

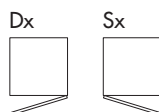
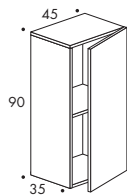

m³ 0,178

Frontale - Front - Façade - Frente - Фасад

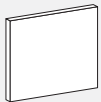
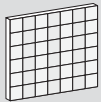
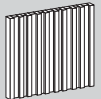
	SMAIL	Dx SMBP1511	Basic wood Basic wood • Basic wood • Basic wood • Basic wood	255	312	366
		Sx SMBP1512	Frassino-Laccato opaco Ash wood-Matt lacquered • Frêne-laqué mat Madera de fresno-lacado mate • Ясень-Лак матовый	311	368	422
	LIDO	Dx SMBP2511	Frassino Ash-wood • Frêne • Madera de fresno • Ясень	594	651	705
		Sx SMBP2512	Laccato lucido Gloss lacquered • Laqué brillant • Lacado brillo • Лак глянец			
	SYMPHONIA	Dx SMBP4511	Frassino Ash-wood • Frêne • Madera de fresno • Ясень	493	550	604
		Sx SMBP4512				

L. 60

1 anta, con 1 ripiano legno

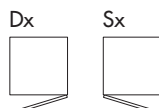
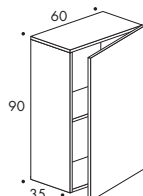

1 door, with 1 wooden shelf • 1 porte avec 1 étagère bois • 1 puerta, con 1 estante de madera

1 дверка, с 1 деревянной полкой

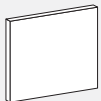
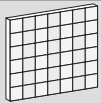

m³ 0,234

Frontale - Front - Façade - Frente - Фасад

	SMAIL	Dx SMBP1521	Basic wood Basic wood • Basic wood • Basic wood • Basic wood	279	341	403
		Sx SMBP1522	Frassino-Laccato opaco Ash wood-Matt lacquered • Frêne-laqué mat Madera de fresno-lacado mate • Ясень-Лак матовый	355	417	479
	LIDO	Dx SMBP2521	Frassino Ash-wood • Frêne • Madera de fresno • Ясень	734	796	858
		Sx SMBP2522	Laccato lucido Gloss lacquered • Laqué brillant • Lacado brillo • Лак глянец			
	SYMPHONIA	Dx SMBP4521	Frassino Ash-wood • Frêne • Madera de fresno • Ясень	641	703	765
		Sx SMBP4522				

Pensile H.90 P.35

Wall-hung unit H.90 D.35 • Élément mural H.90 P.35 • Colgante A.90 P.35 • Навесной шкафчик В.90 Г.35

Di serie con apertura PushPull. Con maniglia su frontale + 36 € cad.

Standard with PushPull opening - With handle + 36€ each one

Ouverture standard pousse-lâche - Avec poignée +36 € chaque

De serie con abertura PushPull - Con tirador + 36€ cad.

Стандартное открывание PushPull - С ручкой на фасаде + 36 €/шт.

Scocca - Carcass - Structure - Estructura - Каркас

Basic wood
Basic wood
Basic wood
Basic wood
Basic wood

Frassino-Laccato opaco
Ash wood-Matt lacquered
Frêne-laqué mat
Madera de fresno-lacado mate
Ясень-Лак матовый

Laccato lucido
Gloss lacquered
Laqué brillant
Lacado brillo
Лак глянец

L. 90

2 ante, con 1 ripiano legno

2 doors, with 1 wooden shelf • 2 portes avec 1 étagère bois • 2 puertas, con 1 estante de madera

2 дверки, с 1 деревянной полкой

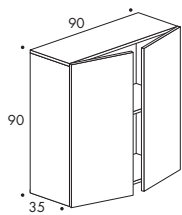

m³ 0,345

Frontale - Front - Façade - Frente - Фасад

	SMAIL	SMBP1530	Basic wood Basic wood • Basic wood • Basic wood • Basic wood	353	424	498
			Frassino-Laccato opaco Ash wood-Matt lacquered • Frêne-laqué mat Madera de fresno-lacado mate • Ясень-Лак матовый	465	536	610
			Laccato lucido Gloss lacquered • Laqué brillant • Lacado brillo • Лак глянец	547	618	692
	LIDO	SMBP2530	Frassino Ash-wood • Frêne • Madera de fresno • Ясень	1.031	1.102	1.176
	SYMPHONIA	SMBP4530	Frassino Ash-wood • Frêne • Madera de fresno • Ясень	829	900	974

L. 90

4 ante, con 1 ripiano legno

4 doors, with 1 wooden shelf • 4 portes avec 1 étagère bois • 4 puertas, con 1 estante de madera

4 дверки, с 1 деревянной полкой

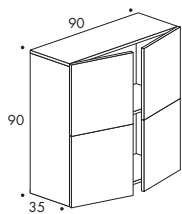

m³ 0,345

Frontale - Front - Façade - Frente - Фасад

	SMAIL	SMBP1534	Basic wood Basic wood • Basic wood • Basic wood • Basic wood	482	553	626
			Frassino-Laccato opaco Ash wood-Matt lacquered • Frêne-laqué mat Madera de fresno-lacado mate • Ясень-Лак матовый	594	665	738
			Laccato lucido Gloss lacquered • Laqué brillant • Lacado brillo • Лак глянец	674	745	818

Pensile H.90 P.35

Wall-hung unit H.90 D.35 • Élément mural H.90 P.35 • Colgante A.90 P.35 • Навесной шкафчик В.90 Г.35

Di serie con apertura PushPull. Con maniglia su frontale + 36 € cad.

Standard with PushPull opening - With handle + 36€ each one

Ouverture standard pousse-lâche - Avec poignée +36 € chaque

De serie con abertura PushPull - Con tirador + 36€ cad.

Стандартное открывание PushPull - С ручкой на фасаде + 36 €/шт.

Scocca - Carcass - Structure - Estructura - Каркас

Basic wood
Basic wood
Basic wood
Basic wood
Basic wood

Frassino-Laccato opaco
Ash wood-Matt lacquered
Frêne-laqué mat
Madera de fresno-lacado mate
Ясень-Лак матовый

Laccato lucido
Gloss lacquered
Laqué brillant
Lacado brillo
Лак глянец

L. 120

2 ante, con 1 ripiano legno

2 doors, with 1 wooden shelf • 2 portes avec 1 étagère bois • 2 puertas, con 1 estante de madera

2 дверки, с 1 деревянной полкой

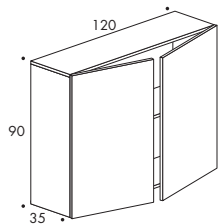

m³ 0,457

Frontale - Front - Façade - Frente - Фасад

	SMAIL	SMBP1540	Basic wood Basic wood • Basic wood • Basic wood • Basic wood	496	512	598
			Frassino-Laccato opaco Ash wood-Matt lacquered • Frêne-laqué mat Madera de fresno-lacado mate • Ясень-Лак матовый	648	664	750
			Laccato lucido Gloss lacquered • Laqué brillant • Lacado brillo • Лак глянец	756	772	858
	LIDO	SMBP2540	Frassino Ash-wood • Frêne • Madera de fresno • Ясень	1.406	1.422	1.508
	SYMPHONIA	SMBP4540	Frassino Ash-wood • Frêne • Madera de fresno • Ясень	1.220	1.236	1.322

L. 120

4 ante, con 1 ripiano legno

4 doors, with 1 wooden shelf • 4 portes avec 1 étagère bois • 4 puertas, con 1 estante de madera

4 дверки, с 1 деревянной полкой

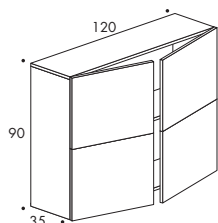

m³ 0,457

Frontale - Front - Façade - Frente - Фасад

	SMAIL	SMBP1544	Basic wood Basic wood • Basic wood • Basic wood • Basic wood	532	667	792
			Frassino-Laccato opaco Ash wood-Matt lacquered • Frêne-laqué mat Madera de fresno-lacado mate • Ясень-Лак матовый	680	815	940
			Laccato lucido Gloss lacquered • Laqué brillant • Lacado brillo • Лак глянец	784	919	1.044
	LIDO	SMBP2544	Frassino Ash-wood • Frêne • Madera de fresno • Ясень	1.512	1.647	1.772

Pensile H.90 P.35

Wall-hung unit H.90 D.35 • Élément mural H.90 P.35 • Colgante A.90 P.35 • Навесной шкафчик В.90 Г.35

Di serie con apertura PushPull. Con maniglia su frontale + 36 € cad.

Standard with PushPull opening - With handle + 36€ each one
Ouverture standard pousse-lâche - Avec poignée +36 € chaque
De serie con abertura PushPull - Con tirador + 36€ cad.

Стандартное открывание PushPull - С ручкой на фасаде + 36 €/шт.

Scocca - Carcass - Structure - Estructura - Каркас

Basic wood
Basic wood
Basic wood
Basic wood

Frassino-Laccato opaco
Ash wood-Matt lacquered
Frêne-laqué mat
Madera de fresno-lacado mate
Ясень-Лак матовый

Laccato lucido
Gloss lacquered
Laqué brillant
Lacado brillo
Лак глянец

L. 90

2 ante, con 1 ripiano legno

2 doors, with 1 wooden shelf • 2 portes avec 1 étagère bois • 2 puertas, con 1 estante de madera

2 дверки, с 1 деревянной полкой

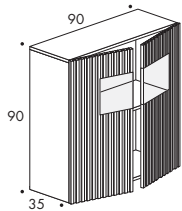

m³ 0,345

Frontale - Front - Façade - Frente - Фасад

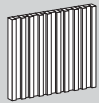

SYMPHONIA

SMBP5531

Frassino
Ash-wood • Frêne • Madera de fresno • Ясень

1.007

1.078

1.152

LUCE OPTIONAL

Optional light • Eclairage optionelle
Luz opcional • Подсветка опция

SMCV1000

m³ 0,001

160

L. 90

2 ante LOW, con 1 ripiano legno

2 doors LOW, with 1 wooden shelf • 2 portes LOW avec 1 étagère bois

2 puertas LOW, con 1 estante de madera • 2 дверки LOW, с 1 деревянной полкой

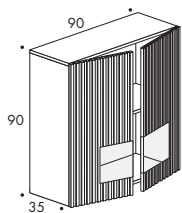

m³ 0,345

Frontale - Front - Façade - Frente - Фасад

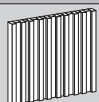

SYMPHONIA

SMBP5532

Frassino
Ash-wood • Frêne • Madera de fresno • Ясень

1.007

1.078

1.152

LUCE OPTIONAL

Optional light • Eclairage optionelle
Luz opcional • Подсветка опция

SMCV1000

m³ 0,001

160

Pensile H.90 / H.120 P.35

Wall-hung unit H.90/H.120 D.35 • Élément mural H.90 / H.120 P.35 • Colgante A.90/A.120 P.35 • Навесной шкафчик B.90/B.120 Г.35

Di serie con apertura PushPull. Con maniglia su frontale + 36 € cad.

Standard with PushPull opening - With handle + 36€ each one

Ouverture standard pousse-lâche - Avec poignée +36 € chaque

De serie con abertura PushPull - Con tirador + 36€ cad.

Стандартное открывание PushPull - С ручкой на фасаде + 36 €/шт.

Scocca - Carcass - Structure - Estructura - Каркас

Basic wood
Basic wood
Basic wood
Basic wood
Basic wood

Frassino-Laccato opaco
Ash wood-Matt lacquered
Frêne-laqué mat
Madera de fresno-lacado mate
Ясень-Лак матовый

Laccato lucido
Gloss lacquered
Laqué brillant
Lacado brillo
Лак глянец

L. 120

2 ante, con 1 ripiano legno

2 doors, with 1 wooden shelf • 2 portes avec 1 étagère bois • 2 puertas, con 1 estante de madera

2 дверки, с 1 деревянной полкой

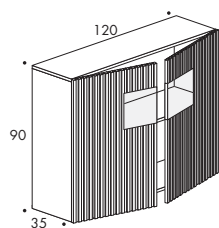

m³ 0,457

Frontale - Front - Façade - Frente - Фасад

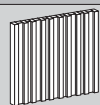

SYMPHONIA

SMBP5540

Frassino

Ash-wood • Frêne • Madera de fresno • Ясень

1.286

1.302

1.388

LUCE OPTIONAL

Optional light • Eclairage optionelle

Luz opcional • Подсветка опция

SMCV1000

m³ 0,001

160

L. 90

2 ante, con 1 ripiano legno e 1 ripiano vetro

2 door, with 1 wooden and 1 glass shelf • 2 portes avec 1 étagère bois et 1 étagère verre 2 puertas, con 1 estante de madera y 1 de cristal • 2 дверки, с 1 деревянной полкой и 1 стеклянными полками

2 дверки, с 1 деревянной полкой и 1 стеклянными полками

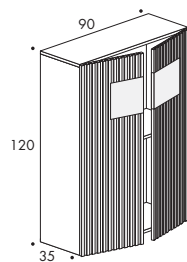

m³ 0,468

Frontale - Front - Façade - Frente - Фасад

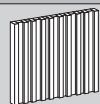

SYMPHONIA

SMBP5630

Frassino

Ash-wood • Frêne • Madera de fresno • Ясень

1.266

1.356

1.436

LUCE OPTIONAL

Optional light • Eclairage optionelle

Luz opcional • Подсветка опция

SMCV1000

m³ 0,001

160

Pensile H.120 P.35

Wall-hung unit H.120 D.35 • Élément mural H.120 P.35 • Colgante A.120 P.35 • Навесной шкафчик В.120 Г.35

Di serie con apertura PushPull. Con maniglia su frontale + 36 € cad.

Standard with PushPull opening - With handle + 36€ each one

Ouverture standard pousse-lâche - Avec poignée +36 € chaque

De serie con abertura PushPull - Con tirador + 36€ cad.

Стандартное открывание PushPull - С ручкой на фасаде + 36 €/шт.

Scocca - Carcass - Structure - Estructura - Каркас

Basic wood
Basic wood
Basic wood
Basic wood
Basic wood

Frassino-Laccato opaco
Ash wood-Matt lacquered
Frêne-laqué mat
Madera de fresno-lacado mate
Ясень-Лак матовый

Laccato lucido
Gloss lacquered
Laqué brillant
Lacado brillo
Лак глянец

L. 30

1 anta, con 1 ripiano legno e 2 ripiani vetro

1 door, with 1 wooden and 2 glass shelves • 1 porte avec 1 étagère bois et 2 étagères verre • 1 puerta, con 1 estante de madera y 2 de cristal • 1 дверка, с 1 деревянной полкой и 2 стеклянными полками

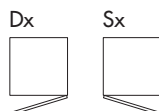
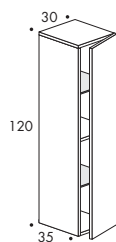

m³ 0,166

Frontale - Front - Façade - Frente - Фасад



SMAIL

Dx
SMBP1601

Basic wood
Basic wood • Basic wood • Basic wood • Basic wood

301

362

419

Sx
SMBP1602

Frassino-Laccato opaco
Ash wood-Matt lacquered • Frêne-laqué mat
Madera de fresno-lacado mate • Ясень-Лак матовый

358

419

476

Laccato lucido
Gloss lacquered • Laqué brillant • Lacado brillo • Лак глянец

398

459

516

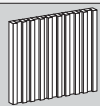

SYMPHONIA

Dx
SMBP4601

Frassino
Ash-wood • Frêne • Madera de fresno • Ясень

547

608

665

Sx
SMBP4602

L. 45

1 anta, con 1 ripiano legno e 2 ripiani vetro

1 door, with 1 wooden and 2 glass shelves • 1 porte avec 1 étagère bois et 2 étagères verre • 1 puerta, con 1 estante de madera y 2 de cristal • 1 дверка, с 1 деревянной полкой и 2 стеклянными полками

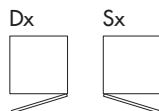
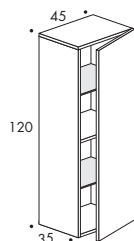

m³ 0,242

Frontale - Front - Façade - Frente - Фасад



SMAIL

Dx
SMBP1611

Basic wood
Basic wood • Basic wood • Basic wood • Basic wood

336

401

463

Sx
SMBP1612

Frassino-Laccato opaco
Ash wood-Matt lacquered • Frêne-laqué mat
Madera de fresno-lacado mate • Ясень-Лак матовый

412

477

539

Laccato lucido
Gloss lacquered • Laqué brillant • Lacado brillo • Лак глянец

466

531

593

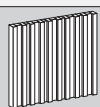

SYMPHONIA

Dx
SMBP4611

Frassino
Ash-wood • Frêne • Madera de fresno • Ясень

704

769

831

Sx
SMBP4612

Pensile H.120 P.35

Wall-hung unit H.120 D.35 • Élément mural H.120 P.35 • Colgante A.120 P.35 • Навесной шкафчик В.120 Г.35

Di serie con apertura PushPull. Con maniglia su frontale + 36 € cad.

Standard with PushPull opening - With handle + 36€ each one

Ouverture standard pousse-lâche - Avec poignée +36 € chaque

De serie con abertura PushPull - Con tirador + 36€ cad.

Стандартное открывание PushPull - С ручкой на фасаде + 36 €/шт.

Scocca - Carcass - Structure - Estructura - Каркас

Basic wood
Basic wood
Basic wood
Basic wood
Basic wood

Frassino-Laccato opaco
Ash wood-Matt lacquered
Frêne-laqué mat
Madera de fresno-lacado mate
Ясень-Лак матовый

Laccato lucido
Gloss lacquered
Laqué brillant
Lacado brillo
Лак глянец

L. 60

1 ante, con 1 ripiano legno e 2 ripiani vetro

1 door, with 1 wooden and 2 glass shelves • 1 porte avec 1 étagère bois et 2 étagères verre • 1 puerta, con 1 estante de madera y 2 de cristal • 1 дверка, с 1 деревянной полкой и 2 стеклянными полками

1 door, with 1 wooden and 2 glass shelves • 1 porte avec 1 étagère bois et 2 étagères verre • 1 puerta, con 1 estante de madera y 2 de cristal • 1 дверка, с 1 деревянной полкой и 2 стеклянными полками

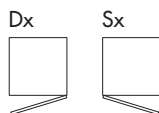
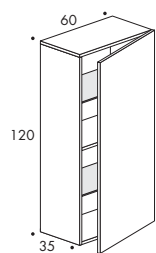

m³ 0,318

Frontale - Front - Façade - Frente - Фасад

	SMAIL	Dx SMBP1621	Basic wood Basic wood • Basic wood • Basic wood • Basic wood	365	432	511
		Sx SMBP1622	Frassino-Laccato opaco Ash wood-Matt lacquered • Frêne-laqué mat Madera de fresno-lacado mate • Ясень-Лак матовый	447	514	593
	SYMPHONIA	Dx SMBP4621	Laccato lucido Gloss lacquered • Laqué brillant • Lacado brillo • Лак глянец	500	567	646
		Sx SMBP4622	Frassino Ash-wood • Frêne • Madera de fresno • Ясень	855	922	1.001

L. 60

2 ante, con 1 ripiano legno e 2 ripiani vetro

2 door, with 1 wooden and 2 glass shelves • 2 portes avec 1 étagère bois et 2 étagères verre • 2 puertas, con 1 estante de madera y 2 de cristal • 2 дверки, с 1 деревянной полкой и 2 стеклянными полками

2 door, with 1 wooden and 2 glass shelves • 2 portes avec 1 étagère bois et 2 étagères verre • 2 puertas, con 1 estante de madera y 2 de cristal • 2 дверки, с 1 деревянной полкой и 2 стеклянными полками

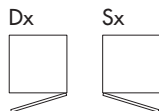
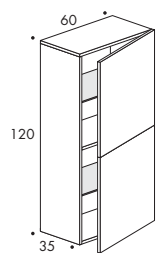

m³ 0,318

Frontale - Front - Façade - Frente - Фасад

	SMAIL	Dx SMBP1623	Basic wood Basic wood • Basic wood • Basic wood • Basic wood	392	459	538
		Sx SMBP1624	Frassino-Laccato opaco Ash wood-Matt lacquered • Frêne-laqué mat Madera de fresno-lacado mate • Ясень-Лак матовый	492	559	638
	GENESIS No pushpull No pushpull • No pousse-lâche No pushpull • Не может быть push-pull	Dx SMBP3623	Laccato lucido Gloss lacquered • Laqué brillant • Lacado brillo • Лак глянец	564	631	710
		Sx SMBP3624	Frassino-Laccato opaco Ash wood-matt lacquered • Frêne-laqué mat Madera de fresno-lacado mate • Ясень-Лак матовый	686	753	832
	SYMPHONIA	Dx SMBP4623	Frassino Ash-wood • Frêne • Madera de fresno • Ясень	930	997	1.076
		Sx SMBP4624				

Pensile H.120 P.35

Wall-hung unit H.120 D.35 • Élément mural H.120 P.35 • Colgante A.120 P.35 • Навесной шкафчик В.120 Г.35

Di serie con apertura PushPull. Con maniglia su frontale + 36 € cad.

Standard with PushPull opening - With handle + 36€ each one

Ouverture standard pousse-lâche - Avec poignée +36 € chaque

De serie con abertura PushPull - Con tirador + 36€ cad.

Стандартное открывание PushPull - С ручкой на фасаде + 36 €/шт.

Scocca - Carcass - Structure - Estructura - Каркас

Basic wood
Basic wood
Basic wood
Basic wood
Basic wood

Frassino-Laccato opaco
Ash wood-Matt lacquered
Frêne-laqué mat
Madera de fresno-lacado mate
Ясень-Лак матовый

Laccato lucido
Gloss lacquered
Laqué brillant
Lacado brillo
Лак глянец

L. 90

2 ante, con 1 ripiano legno e 2 ripiani vetro

2 door, with 1 wooden and 2 glass shelves • 2 portes avec 1 étagère bois et 2 étagères verre • 2 puertas, con 1 estante de madera y 2 de cristal • 2 дверки, с 1 деревянной полкой и 2 стеклянными полками

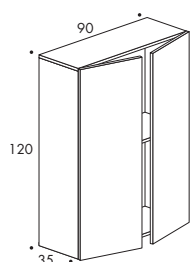

m³ 0,468

Frontale - Front - Façade - Frente - Фасад



SMAIL

SMBP1630

Basic wood

Basic wood • Basic wood • Basic wood • Basic wood

460

550

630

Frassino-Laccato opaco

Ash wood-Matt lacquered • Frêne-laqué mat
Madera de fresno-lacado mate • Ясень-Лак матовый

612

702

782

Laccato lucido

Gloss lacquered • Laqué brillant • Lacado brillo • Лак глянец

720

810

890

Pensile H.150 P.35

Wall-hung unit H.150 D.35 • Élément mural H.150 P.35 • Colgante A.150 P.35 • Навесной шкафчик В.150 Г.35

Di serie con apertura PushPull. Con maniglia su frontale + 36 € cad.

Standard with PushPull opening - With handle + 36€ each one

Ouverture standard pousse-lâche - Avec poignée +36 € chaque

De serie con abertura PushPull - Con tirador + 36€ cad.

Стандартное открывание PushPull - С ручкой на фасаде + 36 €/шт.

Scocca - Carcass - Structure - Estructura - Каркас

Basic wood
Basic wood
Basic wood
Basic wood
Basic wood

Frassino-Laccato opaco
Ash wood-Matt lacquered
Frêne-laqué mat
Madera de fresno-lacado mate
Ясень-Лак матовый

Laccato lucido
Gloss lacquered
Laqué brillant
Lacado brillo
Лак глянец

L. 30

1 anta, con 1 ripiano legno e 2 ripiani vetro

1 door, with 1 wooden and 2 glass shelves • 1 porte avec 1 étagère bois et 2 étagères verre • 1 puerta, con 1 estante de madera y 2 de cristal • 1 дверка, с 1 деревянной полкой и 2 стеклянными полками

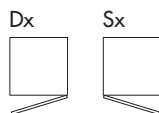
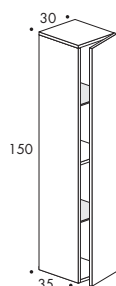

m³ 0,206

Frontale - Front - Façade - Frente - Фасад



SMAIL

Dx
SMBP1701

Basic wood
Basic wood • Basic wood • Basic wood • Basic wood

365

417

490

Frassino-Laccato opaco
Ash wood-Matt lacquered • Frêne-laqué mat
Madera de fresno-lacado mate • Ясень-Лак матовый

433

485

558

Sx
SMBP1702

Laccato lucido
Gloss lacquered • Laqué brillant • Lacado brillo • Лак глянец

481

533

606

L. 45

1 anta, con 1 ripiano legno e 2 ripiani vetro

1 door, with 1 wooden and 2 glass shelves • 1 porte avec 1 étagère bois et 2 étagères verre • 1 puerta, con 1 estante de madera y 2 de cristal • 1 дверка, с 1 деревянной полкой и 2 стеклянными полками

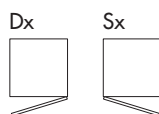
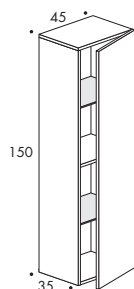

m³ 0,299

Frontale - Front - Façade - Frente - Фасад



SMAIL

Dx
SMBP1711

Basic wood
Basic wood • Basic wood • Basic wood • Basic wood

395

448

529

Frassino-Laccato opaco
Ash wood-Matt lacquered • Frêne-laqué mat
Madera de fresno-lacado mate • Ясень-Лак матовый

493

546

627

Sx
SMBP1712

Laccato lucido
Gloss lacquered • Laqué brillant • Lacado brillo • Лак глянец

576

629

710

Pensile H.150 P.35

Wall-hung unit H.150 D.35 • Élément mural H.150 P.35 • Colgante A.150 P.35 • Навесной шкафчик В.150 Г.35

Di serie con apertura PushPull. Con maniglia su frontale + 36 € cad.

Standard with PushPull opening - With handle + 36€ each one

Ouverture standard pousse-lâche - Avec poignée +36 € chaque

De serie con abertura PushPull - Con tirador + 36€ cad.

Стандартное открывание PushPull - С ручкой на фасаде + 36 €/шт.

Scocca - Carcass - Structure - Estructura - Каркас

Basic wood
Basic wood
Basic wood
Basic wood
Basic wood

Frassino-Laccato opaco
Ash wood-Matt lacquered
Frêne-laqué mat
Madera de fresno-lacado mate
Ясень-Лак матовый

Laccato lucido
Gloss lacquered
Laqué brillant
Lacado brillo
Лак глянец

L. 60

1 anta, con 1 ripiano legno e 2 ripiani vetro

1 door, with 1 wooden and 2 glass shelves • 1 porte avec 1 étagère bois et 2 étagères verre • 1 puerta, con 1 estante de madera y 2 de cristal • 1 дверка, с 1 деревянной полкой и 2 стеклянными полками

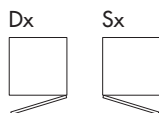
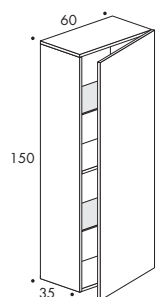

m³ 0,393

Frontale - Front - Façade - Frente - Фасад



SMAIL

Dx
SMBP1721

Basic wood
Basic wood • Basic wood • Basic wood • Basic wood

429

478

543

Sx
SMBP1722

Frassino-Laccato opaco
Ash wood-Matt lacquered • Frêne-laqué mat
Madera de fresno-lacado mate • Ясень-Лак матовый

558

607

672

Laccato lucido
Gloss lacquered • Laqué brillant • Lacado brillo • Лак глянец

691

740

805

Pensile H.180 P.35

Wall-hung unit H.180 D.35 • Élément mural H.180 P.35 • Colgante A.180 P.35 • Навесной шкафчик В.180 Г.35

Di serie con apertura PushPull. Con maniglia su frontale + 36 € cad.

Standard with PushPull opening - With handle + 36€ each one

Ouverture standard pousse-lâche - Avec poignée +36 € chaque

De serie con abertura PushPull - Con tirador + 36€ cad.

Стандартное открывание PushPull - С ручкой на фасаде + 36 €/шт.

Scocca - Carcass - Structure - Estructura - Каркас

Basic wood
Basic wood
Basic wood
Basic wood
Basic wood

Frassino-Laccato opaco
Ash wood-Matt lacquered
Frêne-laqué mat
Madera de fresno-lacado mate
Ясень-Лак матовый

Laccato lucido
Gloss lacquered
Laqué brillant
Lacado brillo
Лак глянец

L. 30

1 anta, con 1 ripiano legno e 2 ripiani vetro

1 door, with 1 wooden and 2 glass shelves • 1 porte avec 1 étagère bois et 2 étagères verre • 1 puerta, con 1 estante de madera y 2 de cristal • 1 дверка, с 1 деревянной полкой и 2 стеклянными полками

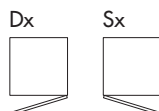
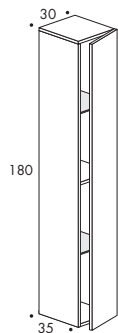

m³ 0,245

Frontale - Front - Façade - Frente - Фасад



SMAIL

Dx
SMBP1801

Basic wood
Basic wood • Basic wood • Basic wood • Basic wood

419

457

541

Sx
SMBP1802

Frassino-Laccato opaco
Ash wood-Matt lacquered • Frêne-laqué mat
Madera de fresno-lacado mate • Ясень-Лак матовый

501

539

623

Laccato lucido
Gloss lacquered • Laqué brillant • Lacado brillo • Лак глянец

554

592

676

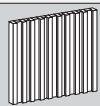

SYMPHONIA

Dx
SMBP4801

Frassino
Ash-wood • Frêne • Madera de fresno • Ясень

775

813

897

Sx
SMBP4802

L. 45

1 anta, con 1 ripiano legno e 2 ripiani vetro

1 door, with 1 wooden and 2 glass shelves • 1 porte avec 1 étagère bois et 2 étagères verre • 1 puerta, con 1 estante de madera y 2 de cristal • 1 дверка, с 1 деревянной полкой и 2 стеклянными полками

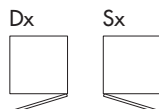
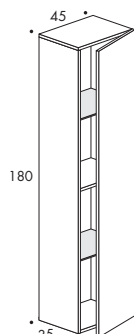

m³ 0,357

Frontale - Front - Façade - Frente - Фасад



SMAIL

Dx
SMBP1811

Basic wood
Basic wood • Basic wood • Basic wood • Basic wood

445

494

583

Sx
SMBP1812

Frassino-Laccato opaco
Ash wood-Matt lacquered • Frêne-laqué mat
Madera de fresno-lacado mate • Ясень-Лак матовый

555

604

693

Laccato lucido
Gloss lacquered • Laqué brillant • Lacado brillo • Лак глянец

670

719

808

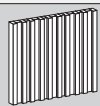

SYMPHONIA

Dx
SMBP4811

Frassino
Ash-wood • Frêne • Madera de fresno • Ясень

994

1.043

1.132

Sx
SMBP4812

Pensile H.180 P.35

Wall-hung unit H.180 D.35 • Élément mural H.180 P.35 • Colgante A.180 P.35 • Навесной шкафчик В.180 Г.35

Di serie con apertura PushPull. Con maniglia su frontale + 36 € cad.

Standard with PushPull opening - With handle + 36€ each one

Ouverture standard pousse-lâche - Avec poignée +36 € chaque

De serie con abertura PushPull - Con tirador + 36€ cad.

Стандартное открывание PushPull - С ручкой на фасаде + 36 €/шт.

Scocca - Carcass - Structure - Estructura - Каркас

Basic wood
Basic wood
Basic wood
Basic wood
Basic wood

Frassino-Laccato opaco
Ash wood-Matt lacquered
Frêne-laqué mat
Madera de fresno-lacado mate
Ясень-Лак матовый

Laccato lucido
Gloss lacquered
Laqué brillant
Lacado brillo
Лак глянец

L. 60

1 anta, con 1 ripiano legno e 2 ripiani vetro

1 door, with 1 wooden and 2 glass shelves • 1 porte avec 1 étagère bois et 2 étagères verre • 1 puerta, con 1 estante de madera y 2 de cristal • 1 дверка, с 1 деревянной полкой и 2 стеклянными полками

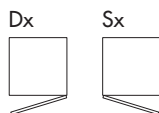
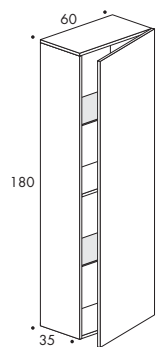

m³ 0,468

Frontale - Front - Façade - Frente - Фасад



SMAIL

Dx
SMBP1821

Basic wood
Basic wood • Basic wood • Basic wood • Basic wood

484

538

634

Sx
SMBP1822

Frassino-Laccato opaco
Ash wood-Matt lacquered • Frêne-laqué mat
Madera de fresno-lacado mate • Ясень-Лак матовый

630

684

780

Laccato lucido
Gloss lacquered • Laqué brillant • Lacado brillo • Лак глянец

789

843

939

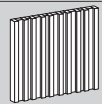

SYMPHONIA

Dx
SMBP4821

Frassino
Ash-wood • Frêne • Madera de fresno • Ясень

1.220

1.274

1.370

Sx
SMBP4822

Vani a giorno

Open units • Module ouvert • Compartimentos • Открытые элементы

L. 60

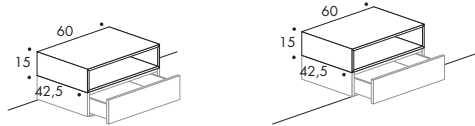

m³ 0,057

Scocca - Carcass - Structure - Estructura - Каркас

SMBG0120	Basic wood Basic wood • Basic wood • Basic wood • Basic wood	139
	Frassino-Laccato opaco Ash wood-Matt lacquered • Frêne-laqué mat • Madera de fresno-lacado mate • Ясень-Лак матовый	184
	Laccato lucido Gloss lacquered • Laqué brillant • Lacado brillo • Лак глянец	220

L. 90

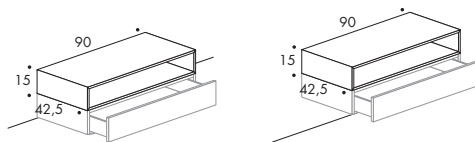

m³ 0,085

Scocca - Carcass - Structure - Estructura - Каркас

SMBG0130	Basic wood Basic wood • Basic wood • Basic wood • Basic wood	151
	Frassino-Laccato opaco Ash wood-Matt lacquered • Frêne-laqué mat • Madera de fresno-lacado mate • Ясень-Лак матовый	212
	Laccato lucido Gloss lacquered • Laqué brillant • Lacado brillo • Лак глянец	265

L. 120

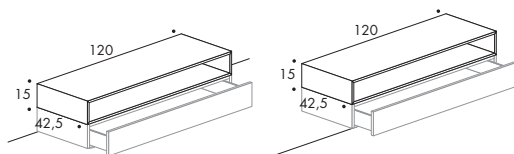

m³ 0,112

Scocca - Carcass - Structure - Estructura - Каркас

SMBG0140	Basic wood Basic wood • Basic wood • Basic wood • Basic wood	167
	Frassino-Laccato opaco Ash wood-Matt lacquered • Frêne-laqué mat • Madera de fresno-lacado mate • Ясень-Лак матовый	249
	Laccato lucido Gloss lacquered • Laqué brillant • Lacado brillo • Лак глянец	314

Vani a giorno

Open units • Module ouvert • Compartimentos • Открытые элементы

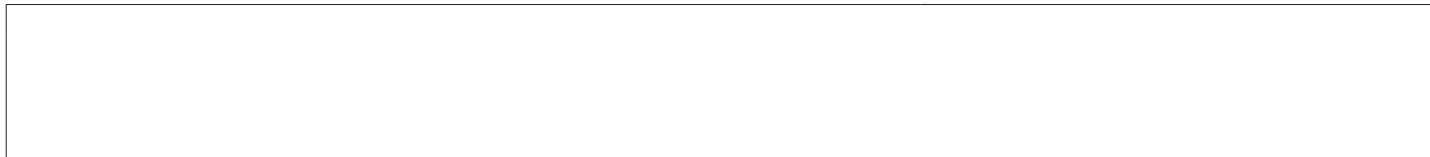

H. 30 L. 30

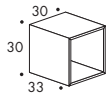

m³ 0,045

Scocca - Carcass - Structure - Estructura - Каркас

SMBG0200	Basic wood Basic wood • Basic wood • Basic wood • Basic wood	132
	Frassino-Laccato opaco Ash wood-Matt lacquered • Frêne-laqué mat • Madera de fresno-lacado mate • Ясень-Лак матовый	197
	Laccato lucido Gloss lacquered • Laqué brillant • Lacado brillo • Лак глянец	248

H. 45 L. 30

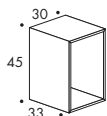

m³ 0,063

Scocca - Carcass - Structure - Estructura -

SMBG0300	Basic wood Basic wood • Basic wood • Basic wood •	139
	Frassino-Laccato opaco Ash wood-Matt lacquered • Frêne-laqué mat • Madera de fresno-lacado mate •	221
	Laccato lucido Gloss lacquered • Laqué brillant • Lacado brillo •	280

H. 45 L. 45

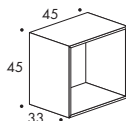

m³ 0,092

Scocca - Carcass - Structure - Estructura - Каркас

SMBG0310	Basic wood Basic wood • Basic wood • Basic wood • Basic wood	149
	Frassino-Laccato opaco Ash wood-Matt lacquered • Frêne-laqué mat • Madera de fresno-lacado mate • Ясень-Лак матовый	243
	Laccato lucido Gloss lacquered • Laqué brillant • Lacado brillo • Лак глянец	314

Libreria pensile

Wall-hung bookcase • Bibliotheque murale • Libreria suspendida • Навесной шкаф для книг

Posizionabile sia verticalmente (dx o sx) che orizzontalmente Dotate di ferramenta per fissaggio a muro

Can be positioned either vertically (right or left) and horizontally - Equipped with hardware for wall mounting
Equipé avec ferrures pour fixation murale - Equipé avec ferrures pour fixation murale
Colocable tanto vertical (derecha o izquierda) y horizontal - Equipado con hardware para montaje en pared
Расположение как вертикальное (правое или левое) так и горизонтальное - Снабжены фурнитурой для крепления к стене

L.

Cod.

m³

Finitura - Finish - Finition - Finitura - Отделка

Laccato opaco
Matt lacquered
Laqué mat
Lacado mate
Лак матовый

H.60

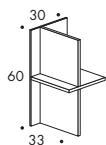

30

SMLI040

0,083

221

H.90

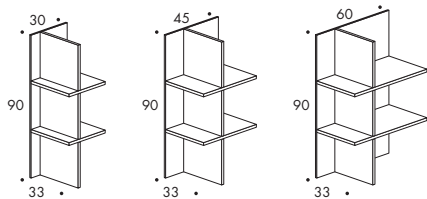

30

SMLI050

0,123

316

45

SMLI051

0,178

338

60

SMLI052

0,234

371

H.120

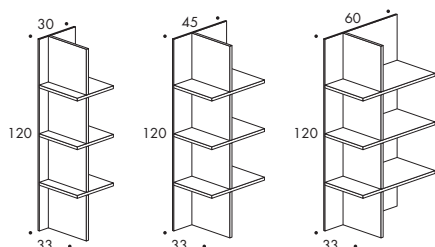

30

SMLI060

0,162

386

45

SMLI061

0,236

429

60

SMLI062

0,310

477

Libreria pensile

Wall-hung bookcase • Bibliotheque murale • Libreria suspendida • Навесной шкаф для книг

Posizionabile sia verticalmente (dx o sx) che orizzontalmente Dotate di ferramenta per fissaggio a muro

Can be positioned either vertically (right or left) and horizontally - Equipped with hardware for wall mounting
Equipé avec ferrures pour fixation murale - Equipé avec ferrures pour fixation murale
Colocable tanto vertical (derecha o izquierda) y horizontal - Equipado con hardware para montaje en pared
Расположение как вертикальное (правое или левое) так и горизонтальное - Снабжены фурнитурой для крепления к стене

L.	Cod.	m ³	Finitura - Finish - Finition - Finitura - Отделка
			Laccato opaco Matt lacquered Laqué mat Lacado mate Лак матовый

H.150

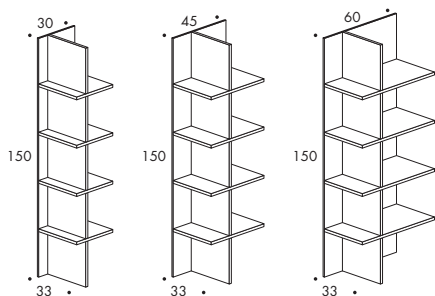

30	SMLI070	0,202	456
45	SMLI071	0,293	519
60	SMLI072	0,385	582

H.180

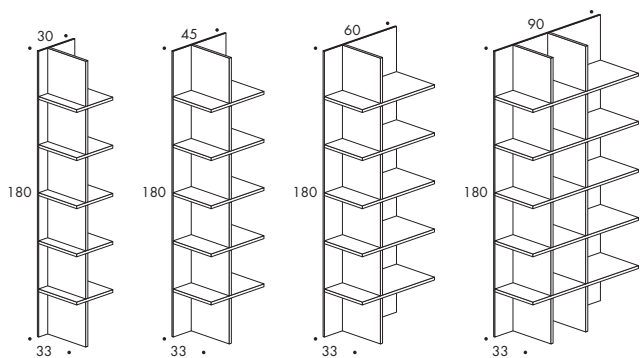

30	SMLI080	0,241	560
45	SMLI081	0,351	640
60	SMLI082	0,460	720
90	SMLI083	0,680	1.082

Modularità

Modularity • Modularité • Modularidad • Модульность

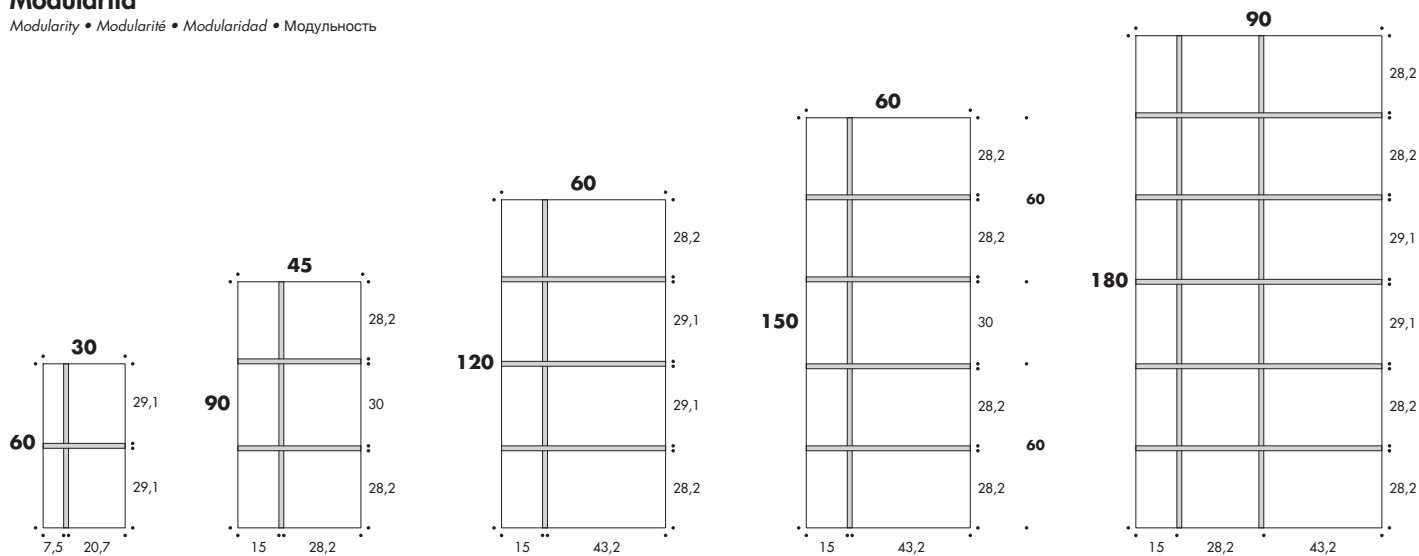

Pedana Sp.4 P.40 con piedini di regolazione

Plinth Th.4 D.40 with adjustment feet • Socle Ep.4 P.40 avec pieds réglables • Tarima e.4 p.40 con patas de ajuste • Подставка толщ. 4Г.40 с регулируемыми ножками

	L.	Cod.	m ³	Finitura - Finish - Finition - Finitura - Отделка	
				Basic wood Basic wood Basic wood Basic wood Basic wood	Frassino-Laccato opaco Ash wood-Matt lacquered Frêne-laqué mat Madera de fresno-lacado mate Ясень-Лак матовый

Sp. 4

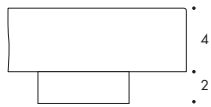
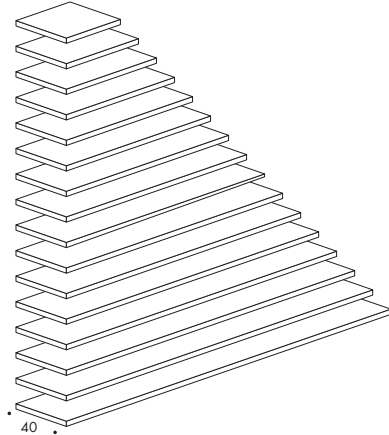

90	SMLP0125	0,018	87	118
105	SMLP0130	0,020	93	128
120	SMLP0135	0,023	99	139
135	SMLP0140	0,026	104	149
150	SMLP0145	0,030	110	161
165	SMLP0150	0,032	128	184
180	SMLP0155	0,035	146	207
195	SMLP0160	0,038	151	218
210	SMLP0165	0,041	157	229
225	SMLP0170	0,044	163	239
240	SMLP0175	0,047	169	250
255	SMLP0180	0,050	174	260
270	SMLP0185	0,053	180	272

Fuori misura pedana

Off-size Plinth • Socle sur mesure • Tarima medida especial • "Подставка ""под размер"""

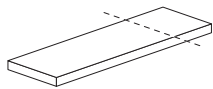

Addebito taglio in larghezza

Surcharge width cutting
Supplément découpe en largeur
Coste del corte en el ancho
Наценка за урез в ширину

40

Home office Sp.5

Home office th.5 • Home office Ep.5 • Home office e.5 • Home office sp.5

	L.	Cod.	m ²	Finitura - Finish - Finition - Finitura - Отделка
				Laccato opaco Matt lacquered Laqué mat Lacado mate Лак матовый

H. 39

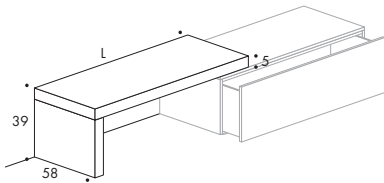

120	SMCH0135	0,053	362
150	SMCH0145	0,063	400
180	SMCH0155	0,074	438
210	SMCH0165	0,084	476
240	SMCH0175	0,094	515

H. 69

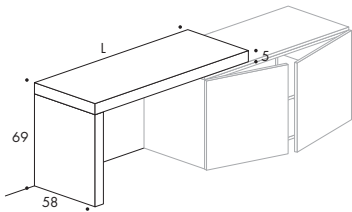

120	SMCH0235	0,063	412
150	SMCH0245	0,073	450
180	SMCH0255	0,084	488
210	SMCH0265	0,094	526
240	SMCH0275	0,104	565

Fuori misura Home office

Off-size Home office • Home office sur mesure • Home office medida especial • "Home office ""под размер"""

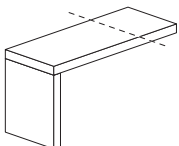

Addebito taglio in larghezza

Surcharge width cutting
Supplément découpe en largeur
Coste del corte en el ancho
Наценка за урез в ширину

40

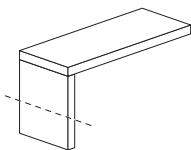

Addebito taglio in altezza

Surcharge height cutting
Supplément découpe en hauteur
Coste del corte en el alto
Наценка за урез в высоту

40

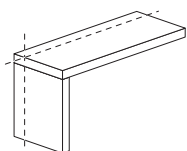

Addebito taglio in profondità

Surcharge depth cutting
Supplément découpe en profondeur
Coste del corte en profundidad
Наценка за урез в глубину

80

Boiserie

Wall panels • Panneau mural • Paneles de pared • Стеновые панели

	L.	Cod.	m ³	Finitura - Finish - Finition - Finitura - Отделка		
				Basic wood Basic wood Basic wood Basic wood Basic wood	Frassino-Laccato opaco Ash wood-Matt lacquered Frêne-laqué mat Madera de fresno-lacado mate Ясень-Лак матовый	Laccato lucido Gloss lacquered Laqué brillant Lacado brillo Лак глянец

H. 30

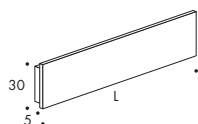

90	SMCB0225	0,015	116	132	193
105	SMCB0230	0,017	123	145	210
120	SMCB0235	0,020	130	145	210
135	SMCB0240	0,022	137	185	285
150	SMCB0245	0,025	144	185	285
165	SMCB0250	0,027	151	185	285
180	SMCB0255	0,030	157	185	285
195	SMCB0260	0,032	163	238	347
210	SMCB0265	0,034	169	238	347
225	SMCB0270	0,037	175	238	347
240	SMCB0275	0,040	181	238	347

H. 60

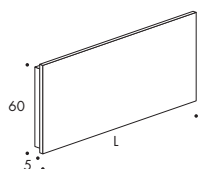

90	SMCB0425	0,030	152	190	248
105	SMCB0430	0,034	158	250	375
120	SMCB0435	0,039	164	250	375
135	SMCB0440	0,044	171	325	495
150	SMCB0445	0,049	178	325	495
165	SMCB0450	0,053	185	325	495
180	SMCB0455	0,058	192	325	495
195	SMCB0460	0,063	199	417	615
210	SMCB0465	0,068	206	417	615
225	SMCB0470	0,073	213	417	615
240	SMCB0475	0,077	220	417	615

H. 90

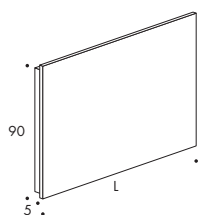

90	SMCB0525	0,044	186	220	280
105	SMCB0530	0,051	192	290	450
120	SMCB0535	0,058	198	290	450
135	SMCB0540	0,065	206	370	570
150	SMCB0545	0,072	214	370	570
165	SMCB0550	0,080	222	370	570
180	SMCB0555	0,087	230	370	570
195	SMCB0560	0,094	238	477	695
210	SMCB0565	0,101	246	477	695
225	SMCB0570	0,108	254	477	695
240	SMCB0575	0,115	260	477	695

Boiserie con luce

Wall panels with light • Panneau mural avec éclairage • Paneles de pared con luz • Стеновые панели с подсветкой

	L.	Cod.	m ³	Finitura - Finish - Finition - Finitura - Отделка		
				Basic wood Basic wood Basic wood Basic wood	Frassino-Laccato opaco Ash wood-Matt lacquered Frêne-laqué mat Madera de fresno-lacado mate Ясень-Лак матовый	Laccato lucido Gloss lacquered Laqué brillant Lacado brillo Лак глянец

H. 30

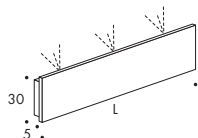

90	SMCB1225	0,015	241	257	318
105	SMCB1230	0,017	248	270	335
120	SMCB1235	0,020	260	275	340
135	SMCB1240	0,022	267	315	415
150	SMCB1245	0,025	299	340	440
165	SMCB1250	0,027	306	340	440
180	SMCB1255	0,030	322	350	450
195	SMCB1260	0,032	328	403	512
210	SMCB1265	0,034	344	413	522
225	SMCB1270	0,037	350	413	522
240	SMCB1275	0,040	366	423	532

H. 60

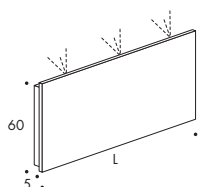

90	SMCB1425	0,030	277	315	373
105	SMCB1430	0,034	283	375	500
120	SMCB1435	0,039	294	380	505
135	SMCB1440	0,044	301	455	625
150	SMCB1445	0,049	333	480	650
165	SMCB1450	0,053	340	480	650
180	SMCB1455	0,058	357	490	660
195	SMCB1460	0,063	364	582	780
210	SMCB1465	0,068	381	592	790
225	SMCB1470	0,073	388	592	790
240	SMCB1475	0,077	405	602	800

H. 90

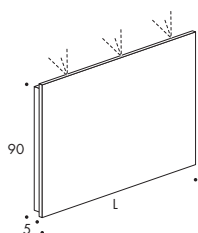

90	SMCB1525	0,044	311	345	405
105	SMCB1530	0,051	317	415	575
120	SMCB1535	0,058	328	420	580
135	SMCB1540	0,065	336	500	700
150	SMCB1545	0,072	369	525	725
165	SMCB1550	0,080	377	525	725
180	SMCB1555	0,087	395	535	735
195	SMCB1560	0,094	403	642	860
210	SMCB1565	0,101	421	652	870
225	SMCB1570	0,108	429	652	870
240	SMCB1575	0,115	445	662	880

Boiserie

Wall panels • Panneau mural • Paneles de pared • Стеновые панели

Fuori misura Boiserie

Off-size Wall panels • Panneau mural sur mesure • Paneles de pared medidas especiales • "Стеновые панели "под размер""

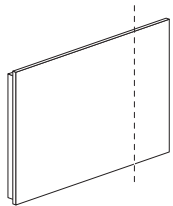

Addebito taglio in larghezza

Surcharge width cutting
Supplément découpe en largeur
Coste del corte en el ancho
Наценка за урез в ширину

40

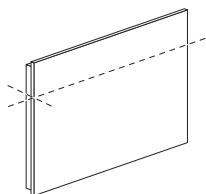

Addebito taglio in altezza

Surcharge height cutting
Supplément découpe en hauteur
Coste del corte en el alto
Наценка за урез в высоту

40

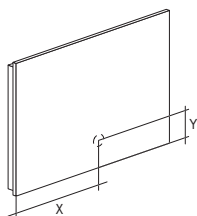

Addebito foro passacavi Ø 6 cm.

Indicare la posizione (X+Y, misura a centro foro)

Surcharge hole for cabling Ø 6 cm Specify position (X+Y, measure to the center hole)
Supplément découpe passage de câbles Ø 6 cm Indiquer la position (X+Y, dimension centre trou)
Coste cable agujero de Ø 6 cm. Indicar la posición (X+Y, medida al agujero central)
Наценка за отверстие для кабеля Ø 6 см Указать расположение (X+Y, размер в центре отверстия)

47

Ripiani interni vetro per basi e pensili

Internal glass shelves for base and wall-hung units • Étagères intérieur verre pour bases et éléments murales • Estante interior de cristal para bases y colgantes • Внутренние стеклянные полки для оснований и навесных шкафчиков

	L.	Cod.	m ²	Finitura - Finish - Finition - Finitura - Отделка
				Vetro trasparente Transparent glass Verre transparent Cristal transparente Прозрачное стекло

Ripiani per PENSILI P. 35

Shelves for wall-hung units D.35

Étagères pour ELEMENTS SUSPENDUS P.35

Estante para colgantes P.35

Полки для НАВЕСНЫХ ШКАФЧИКОВ ГЛ. 35

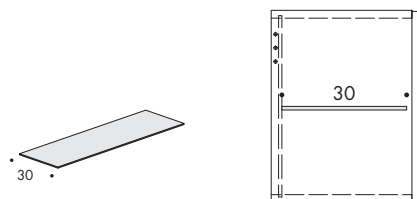

0,8

30	SMCVR110	0,003	45
45	SMCVR120	0,005	45
60	SMCVR130	0,006	45
90	SMCVR140	0,010	45
120	SMCVR150	0,006	45

Ripiani per BASI P. 45

Shelves for base units D.45

Étagères pour ELEMENTS BASES P.45

Estante para bases P.45

Полки для ОСНОВАНИЙ ГЛ. 45

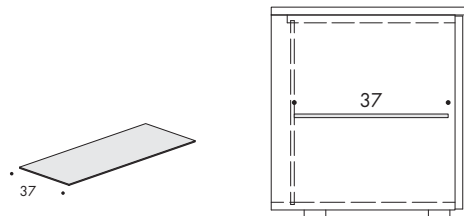

0,8

45	SMCVR220	0,006	45
60	SMCVR230	0,008	45
90	SMCVR240	0,012	45
120	SMCVR250	0,008	45

Ripiani per BASI P. 57,5

Shelvw for base units D.57,5

Étagères pour ELEMENTS BASES P.57,5

Estante para bases P.57,5

Полки для ОСНОВАНИЙ ГЛ. 57,5

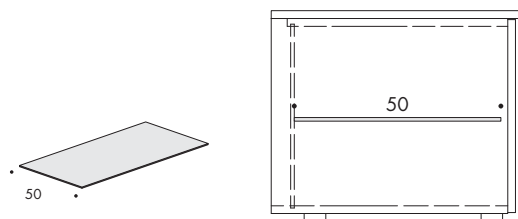

0,8

45	SMCVR320	0,007	45
60	SMCVR330	0,010	45
90	SMCVR340	0,015	45
120	SMCVR350	0,010	45

Mensole P.25

Shelves D.25 • Etagères P.25 • Baldas p.25 • Полки Г.25

L.	Cod.	m³	Finitura - Finish - Finition - Finitura - Отделка		
			Basic wood Basic wood Basic wood Basic wood	Frassino-Laccato opaco Ash wood-Matt lacquered Frêne-laqué mat Madera de fresno-lacado mate Ясень-Лак матовый	Laccato lucido Gloss lacquered Laqué brillant Lacado brillo Лак глянец

Legno Sp.3 cm

Dotate di ferramenta per fissaggio a muro

wood th.3cm - Equipped with hardware for wall mounting

Bois ép.3 cm - Equipé avec ferrures pour fixation murale

Madera es.3cm - Equipado con hardware para montaje en pared

Дерево толщ.3см - Снабжены фурнитурой для крепления к стене

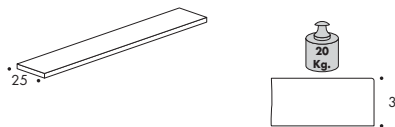

Portata massima 20kg uniformemente distribuiti (compreso il peso del mobile)

Maximum capacity 20kg evenly distributed (including the weight of the cabinet)
20 kg de capacité maximale répartie uniformément (y compris le poids de l'armoire)

20kg máxima capacidad distribuida de manera uniforme (incluyendo el peso del armario)

Макс. нагрузка 20 кг равномерно распределённых (вместе с весом модуля)

60	SMCM1200	0,005	84	108	124
90	SMCM1300	0,007	89	125	150
120	SMCM1400	0,010	95	143	175
150	SMCM1500	0,012	109	169	209
180	SMCM1600	0,015	115	187	233

Fuori misura mensole legno

Off-size wood shelves • Etagères bois sur mesure • Estantes de madera medidas especiales • "Деревянные полки ""под размер"""

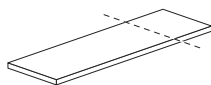

Addebito taglio in larghezza

Surcharge width cutting

Supplément découpe en largeur

Coste del corte en el ancho

Наценка за урез в ширину

40

Vetro trasparente Sp. 0,8 cm.

Dotate di ferramenta per fissaggio a muro

Transparent glass th.0,8cm - Equipped with hardware for wall mounting

Verre transparent ép.0,8 cm - Equipé avec ferrures pour fixation murale

Cristal transparente es.0,8cm - Equipado con hardware para montaje en pared

Прозрачное стекло толщ.0,8см - Снабжены фурнитурой для крепления к стене

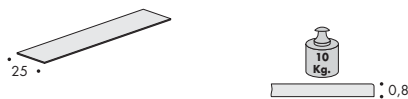

Portata massima 10kg uniformemente distribuiti (compreso il peso del mobile)

Maximum capacity 10kg evenly distributed (including the weight of the cabinet)
10 kg de capacité maximale répartie uniformément (y compris le poids de l'armoire)

10kg máxima capacidad distribuida de manera uniforme (incluyendo el peso del armario)

Макс. нагрузка 10 кг равномерно распределённых (вместе с весом модуля)

60	SMCM2200	0,006		69	
90	SMCM2300	0,008		76	
120	SMCM2400	0,011		85	

Madie H. 63,5 P.58 complete di piedini H. 1,7

Sideboards H. 63,5 D.58 with feet H.1,7 included • Bahut H.63,5 P.58 avec verins H.1,7 inclus • Aparadores H.63,5 P.58 con piernas A.1,7 incluydas • Напольный шкаф В.63,5Г.58 включены ножки В1,7

Di serie con apertura PushPull. Con maniglia su frontale + 36 € cad.

Standard with PushPull opening - With handle + 36€ each one
Ouverture standard pousse-lâche - Avec poignée +36 € chaque
De serie con abertura PushPull - Con tirador + 36€ cad.

Стандартное открывание PushPull - С ручкой на фасаде + 36 €/шт.

Scocca - Carcass - Structure - Estructura - Каркас

Basic wood
Basic wood
Basic wood
Basic wood
Basic wood

Frassino-Laccato opaco
Ash wood-Matt lacquered
Frêne-laqué mat
Madera de fresno-lacado mate
Ясень-Лак матовый

Laccato lucido
Gloss lacquered
Laqué brillant
Lacado brillo
Лак глянец

L. 135

L.135 (45+45+45)

W.135 (45+45+45) • L.135 (45+45+45) • L.135 (45+45+45) • Ш.135 (45+45+45)

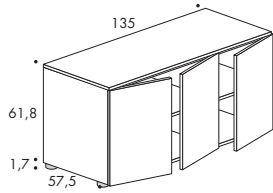

m³ 0,582

Frontale - Front - Façade - Frente - Фасад

	SMAIL	SMMA1120	Basic wood Basic wood • Basic wood • Basic wood • Basic wood	685	763	952
			Frassino-Laccato opaco Ash wood-Matt lacquered • Frêne-laqué mat Madera de fresno-lacado mate • Ясень-Лак матовый	796	874	1.063
			Laccato lucido Gloss lacquered • Laqué brillant • Lacado brillo • Лак глянец	874	952	1.141
	LIDO	SMMA2120	Frassino Ash-wood • Frêne • Madera de fresno • Ясень	1.420	1.498	1.687
	SYMPHONIA	SMMA4120	Frassino Ash-wood • Frêne • Madera de fresno • Ясень	1.204	1.282	1.471

L. 180

L.180 (45+45+45+45)

W.180 (45+45+45+45) • L.180 (45+45+45+45) • L.180 (45+45+45+45) • Ш.180 (45+45+45+45)

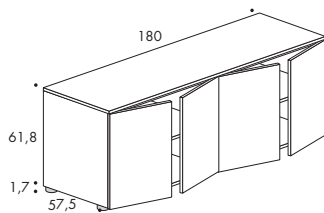

m³ 0,768

Frontale - Front - Façade - Frente - Фасад

	SMAIL	SMMA1140	Basic wood Basic wood • Basic wood • Basic wood • Basic wood	806	888	1.108
			Frassino-Laccato opaco Ash wood-Matt lacquered • Frêne-laqué mat Madera de fresno-lacado mate • Ясень-Лак матовый	954	1.036	1.256
			Laccato lucido Gloss lacquered • Laqué brillant • Lacado brillo • Лак глянец	1.058	1.140	1.360
	LIDO	SMMA2140	Frassino Ash-wood • Frêne • Madera de fresno • Ясень	1.786	1.868	2.088
	SYMPHONIA	SMMA4140	Frassino Ash-wood • Frêne • Madera de fresno • Ясень	1.498	1.580	1.800

Madie H. 63,5 P.58 complete di piedini H. 1,7

Sideboards H. 63,5 D.58 with feet H.1,7 included • Bahut H.63,5 P.58 avec verins H.1,7 inclus • Aparadores H.63,5 P.58 con piernas A.1,7 incluydas • Напольный шкаф В.63,5 Г.58 включены ножки В1,7

Di serie con apertura PushPull. Con maniglia su frontale + 36 € cad.

Standard with PushPull opening - With handle + 36€ each one

Ouverture standard pousse-lâche - Avec poignée +36 € chaque

De serie con abertura PushPull - Con tirador + 36€ cad.

Стандартное открывание PushPull - С ручкой на фасаде + 36 €/шт.

Scocca - Carcass - Structure - Estructura - Каркас

Basic wood
Basic wood
Basic wood
Basic wood
Basic wood

Frassino-Laccato opaco
Ash wood-Matt lacquered
Frêne-laqué mat
Madera de fresno-lacado mate
Ясень-Лак матовый

Laccato lucido
Gloss lacquered
Laqué brillant
Lacado brillo
Лак глянец

L. 225

L.225 (45+45+45+45+45)

W.225 (45+45+45+45+45) • L.225 (45+45+45+45+45) • L.225 (45+45+45+45+45)

Ll.225 (45+45+45+45+45)

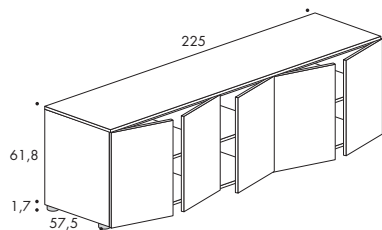

m³ 0,966

Frontale - Front - Façade - Frente - Фасад

	SMAIL	SMMA1150	Basic wood Basic wood • Basic wood • Basic wood • Basic wood	1.072	1.187	1.481
			Frassino-Laccato opaco Ash wood-Matt lacquered • Frêne-laqué mat Madera de fresno-lacado mate • Ясень-Лак матовый	1.257	1.372	1.666
			Laccato lucido Gloss lacquered • Laqué brillant • Lacado brillo • Лак глянец	1.387	1.502	1.796
	LIDO	SMMA2150	Frassino Ash-wood • Frêne • Madera de fresno • Ясень	2.297	2.412	2.706
	SYMPHONIA	SMMA4150	Frassino Ash-wood • Frêne • Madera de fresno • Ясень	1.937	2.052	2.346

Zoccoli alluminio (OPTIONAL)

Aluminium socle (optional)

Socle aluminium (optionnelle)

Patas de aluminio (opcional)

Алюминиевый цоколь (Опция)

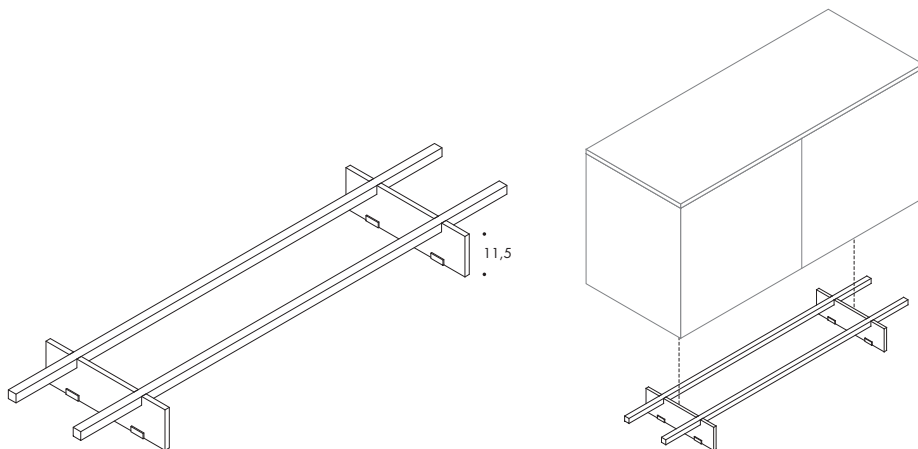

L.	Cod.	m ³	
135	SMMZ0140	0,014	199
180	SMMZ0155	0,016	232
225	SMMZ0170	0,022	255

Madie H. 63,5 P.58 complete di piedini H. 1,7

Sideboards H. 63,5 D.58 with feet H.1,7 included • Bahut H.63,5 P.58 avec verins H.1,7 inclus • Aparadores H.63,5 P.58 con piernas A.1,7 incluydas • Напольный шкаф В.63,5Г.58 включены ножки В1,7

Di serie con apertura PushPull. Con maniglia su frontale + 36 € cad.

Standard with PushPull opening - With handle + 36€ each one
Ouverture standard pousse-lâche - Avec poignée +36 € chaque
De serie con abertura PushPull - Con tirador + 36€ cad.

Стандартное открывание PushPull - С ручкой на фасаде + 36 €/шт.

Scocca - Carcass - Structure - Estructura - Каркас

Basic wood
Basic wood
Basic wood
Basic wood
Basic wood

Frassino-Laccato opaco
Ash wood-Matt lacquered
Frêne-laqué mat
Madera de fresno-lacado mate
Ясень-Лак матовый

Laccato lucido
Gloss lacquered
Laqué brillant
Lacado brillo
Лак глянец

L. 120

L.120 (60+60)

W.120 (60+60) • L.120 (60+60) • L.120 (60+60) • Ш.120 (60+60)

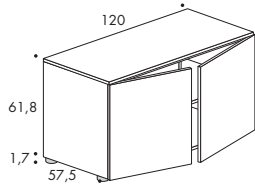

m³ 0,508

Frontale - Front - Façade - Frente - Фасад

	SMAIL	SMMA1110	Basic wood Basic wood • Basic wood • Basic wood • Basic wood	486	528	653
			Frassino-Laccato opaco Ash wood-Matt lacquered • Frêne-laqué mat Madera de fresno-lacado mate • Ясень-Лак матовый	586	628	753
			Laccato lucido Gloss lacquered • Laqué brillant • Lacado brillo • Лак глянец	658	700	825
	GENESIS No pushpull No pushpull • No pousse-lâche No pushpull • Не может быть push-pull	SMMA3110	Frassino-Laccato opaco Ash wood-matt lacquered • Frêne-laqué mat Madera de fresno-lacado mate • Ясень-Лак матовый	780	822	947
	LIDO	SMMA2110	Frassino Ash-wood • Frêne • Madera de fresno • Ясень	1.108	1.150	1.275
	SYMPHONIA	SMMA4110	Frassino Ash-wood • Frêne • Madera de fresno • Ясень	1.024	1.066	1.191

L. 180

L.180 (60+60+60)

W.180 (60+60+60) • L.180 (60+60+60) • L.180 (60+60+60) • Ш.180 (60+60+60)

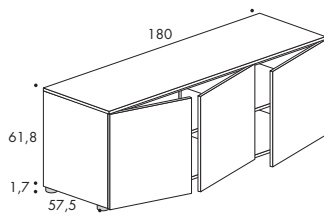

m³ 0,767

Frontale - Front - Façade - Frente - Фасад

	SMAIL	SMMA1130	Basic wood Basic wood • Basic wood • Basic wood • Basic wood	778	863	1.081
			Frassino-Laccato opaco Ash wood-Matt lacquered • Frêne-laqué mat Madera de fresno-lacado mate • Ясень-Лак матовый	928	1.013	1.231
			Laccato lucido Gloss lacquered • Laqué brillant • Lacado brillo • Лак глянец	1.036	1.121	1.339
	GENESIS No pushpull No pushpull • No pousse-lâche No pushpull • Не может быть push-pull	SMMA3130	Frassino-Laccato opaco Ash wood-matt lacquered • Frêne-laqué mat Madera de fresno-lacado mate • Ясень-Лак матовый	1.219	1.304	1.522
	LIDO	SMMA2130	Frassino Ash-wood • Frêne • Madera de fresno • Ясень	1.711	1.796	2.014
	SYMPHONIA	SMMA4130	Frassino Ash-wood • Frêne • Madera de fresno • Ясень	1.585	1.670	1.888

Madie H. 63,5 P.58 complete di piedini H. 1,7

Sideboards H. 63,5 D.58 with feet H.1,7 included • Bahut H.63,5 P.58 avec verins H.1,7 inclus • Aparadores H.63,5 P.58 con piernas A.1,7 incluydas • Напольный шкаф В.63,5 Г.58 включены ножки В1,7

Di serie con apertura PushPull. Con maniglia su frontale + 36 € cad.

Standard with PushPull opening - With handle + 36€ each one
Ouverture standard pousse-lâche - Avec poignée +36 € chaque
De serie con abertura PushPull - Con tirador + 36€ cad.
Стандартное открывание PushPull - С ручкой на фасаде + 36 €/шт.

Scocca - Carcass - Structure - Estructura - Каркас

Basic wood Basic wood Basic wood Basic wood	Frassino-Laccato opaco Ash wood-Matt lacquered Frêne-laqué mat Madera de fresno-lacado mate Ясень-Лак матовый	Laccato lucido Gloss lacquered Laqué brillant Lacado brillo Лак глянец
--	---	--

L. 240

L.240 (60+60+60+60)

W.240 (60+60+60+60) • L.240 (60+60+60+60) • L.240 (60+60+60+60) • Ш.240 (60+60+60+60)

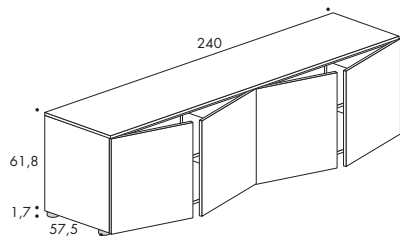

m³ 1,016

Frontale - Front - Façade - Frente - Фасад

	SMAIL	SMMA1160	Basic wood Basic wood • Basic wood • Basic wood • Basic wood	939	1.022	1.272
			Frassino-Laccato opaco Ash wood-Matt lacquered • Frêne-laqué mat Madera de fresno-lacado mate • Ясень-Лак матовый	1.139	1.222	1.472
			Laccato lucido Gloss lacquered • Laqué brillant • Lacado brillo • Лак глянец	1.283	1.366	1.616
	GENESIS No pushpull No pushpull • No pousse-lâche No pushpull • Не может быть push-pull	SMMA3160	Frassino-Laccato opaco Ash wood-matt lacquered • Frêne-laqué mat Madera de fresno-lacado mate • Ясень-Лак матовый	1.527	1.610	1.860
	LIDO	SMMA2160	Frassino Ash-wood • Frêne • Madera de fresno • Ясень	2.183	2.266	2.516
	SYMPHONIA	SMMA4160	Frassino Ash-wood • Frêne • Madera de fresno • Ясень	2.015	2.098	2.348

Zoccoli alluminio (OPTIONAL)

Aluminium socle (optional)
Socle aluminium (optionelle)
Patas de aluminio (opcional)
Аллюминиевый цоколь (Опция)

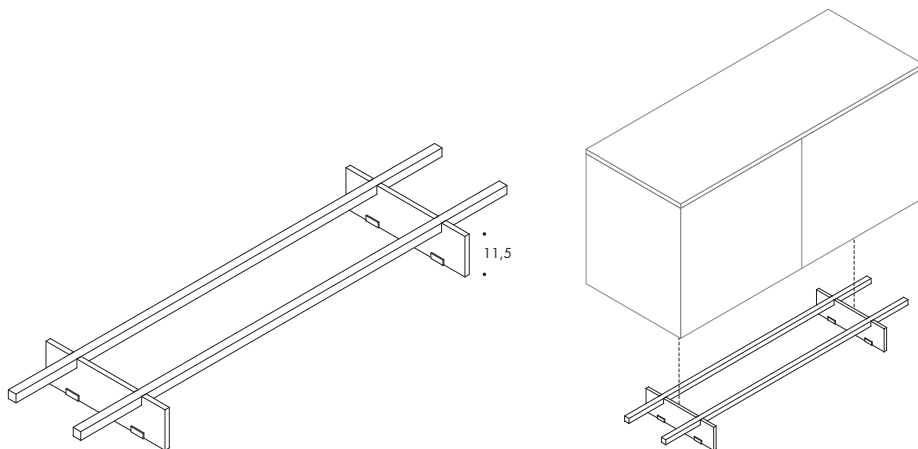

L.	Cod.	m ³	
120	SMMZ0135	0,013	190
180	SMMZ0155	0,016	232
240	SMMZ0175	0,022	264

Madie H. 93,5 P.58 complete di piedini H. 1,7

Sideboards H. 93,5 D.58 with feet H.1,7 included • Bahut H.93,5 P.58 avec verins H.1,7 inclus • Aparadores H.93,5 P.58 con piernas A.1,7 incluydas • Напольный шкаф В.93,5Г.58 включены ножки В1,7

Di serie con apertura PushPull. Con maniglia su frontale + 36 € cad.

Standard with PushPull opening - With handle + 36€ each one
Ouverture standard pousse-lâche - Avec poignée +36 € chaque
De serie con abertura PushPull - Con tirador + 36€ cad.

Стандартное открывание PushPull - С ручкой на фасаде + 36 €/шт.

Scocca - Carcass - Structure - Estructura - Каркас

Basic wood
Basic wood
Basic wood
Basic wood
Basic wood

Frassino-Laccato opaco
Ash wood-Matt lacquered
Frêne-laqué mat
Madera de fresno-lacado mate
Ясень-Лак матовый

Laccato lucido
Gloss lacquered
Laqué brillant
Lacado brillo
Лак глянец

L. 135

L.135 (45+45+45)

W.135 (45+45+45) • L.135 (45+45+45) • L.135 (45+45+45) • Ш.135 (45+45+45)

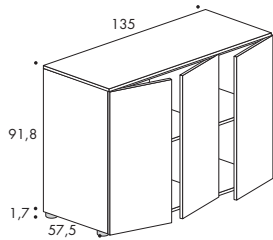

m³ 0,851

Frontale - Front - Façade - Frente - Фасад

	SMAIL	SMMA1220	Basic wood Basic wood • Basic wood • Basic wood • Basic wood	750	876	1.077
			Frassino-Laccato opaco Ash wood-Matt lacquered • Frêne-laqué mat Madera de fresno-lacado mate • Ясень-Лак матовый	918	1.044	1.245
			Laccato lucido Gloss lacquered • Laqué brillant • Lacado brillo • Лак глянец	1.041	1.167	1.368
	LIDO	SMMA2220	Frassino Ash-wood • Frêne • Madera de fresno • Ясень	1.767	1.893	2.094
	SYMPHONIA	SMMA4220	Frassino Ash-wood • Frêne • Madera de fresno • Ясень	1.464	1.590	1.791

L. 180

L.180 (45+45+45+45)

W.180 (45+45+45+45) • L.180 (45+45+45+45) • L.180 (45+45+45+45) • Ш.180 (45+45+45+45)

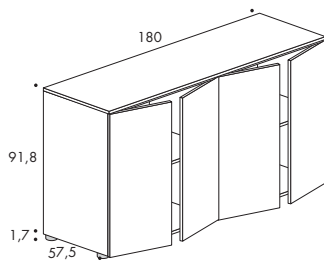

m³ 1,122

Frontale - Front - Façade - Frente - Фасад

	SMAIL	SMMA1240	Basic wood Basic wood • Basic wood • Basic wood • Basic wood	878	1.006	1.236
			Frassino-Laccato opaco Ash wood-Matt lacquered • Frêne-laqué mat Madera de fresno-lacado mate • Ясень-Лак матовый	1.102	1.230	1.460
			Laccato lucido Gloss lacquered • Laqué brillant • Lacado brillo • Лак глянец	1.266	1.394	1.624
	LIDO	SMMA2240	Frassino Ash-wood • Frêne • Madera de fresno • Ясень	2.234	2.362	2.592
	SYMPHONIA	SMMA4240	Frassino Ash-wood • Frêne • Madera de fresno • Ясень	1.830	1.958	2.188

Madie H. 93,5 P.58 complete di piedini H. 1,7

Sideboards H. 93,5 D.58 with feet H.1,7 included • Bahut H.93,5 P.58 avec verins H.1,7 inclus • Aparadores H.93,5 P.58 con piernas A.1,7 incluydas • Напольный шкаф В.93,5 Г.58 включены ножки В1,7

Di serie con apertura PushPull. Con maniglia su frontale + 36 € cad.

Standard with PushPull opening - With handle + 36€ each one

Ouverture standard pousse-lâche - Avec poignée +36 € chaque

De serie con abertura PushPull - Con tirador + 36€ cad.

Стандартное открывание PushPull - С ручкой на фасаде + 36 €/шт.

Scocca - Carcass - Structure - Estructura - Каркас

Basic wood
Basic wood
Basic wood
Basic wood
Basic wood

Frassino-Laccato opaco
Ash wood-Matt lacquered
Frêne-laqué mat
Madera de fresno-lacado mate
Ясень-Лак матовый

Laccato lucido
Gloss lacquered
Laqué brillant
Lacado brillo
Лак глянец

L. 225

L.225 (45+45+45+45+45)

W.225 (45+45+45+45+45) • L.225 (45+45+45+45+45) • L.225 (45+45+45+45+45)

Ll.225 (45+45+45+45+45)

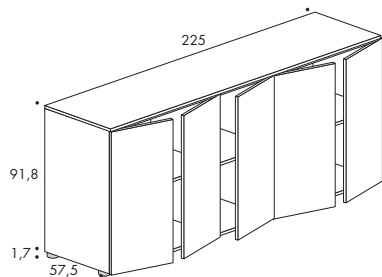

m³ 1,412

Frontale - Front - Façade - Frente - Фасад

Frontale	Code	Material	Basic wood	Frassino-Laccato opaco	Laccato lucido
SMAIL	SMMA1250	Basic wood Basic wood • Basic wood • Basic wood • Basic wood	1.173	1.359	1.670
		Frassino-Laccato opaco Ash wood-Matt lacquered • Frêne-laqué mat Madera de fresno-lacado mate • Ясень-Лак матовый	1.453	1.639	1.950
		Laccato lucido Gloss lacquered • Laqué brillant • Lacado brillo • Лак глянец	1.658	1.844	2.155
LIDO	SMMA2250	Frassino Ash-wood • Frêne • Madera de fresno • Ясень	2.868	3.054	3.365
SYMPHONIA	SMMA4250	Frassino Ash-wood • Frêne • Madera de fresno • Ясень	2.363	2.549	2.860

Zoccoli alluminio (OPTIONAL)

Aluminium socle (optional)

Socle aluminium (optionelle)

Patas de aluminio (opcional)

Алюминиевый цоколь (Опция)

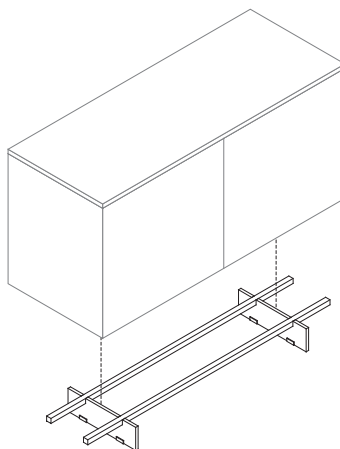
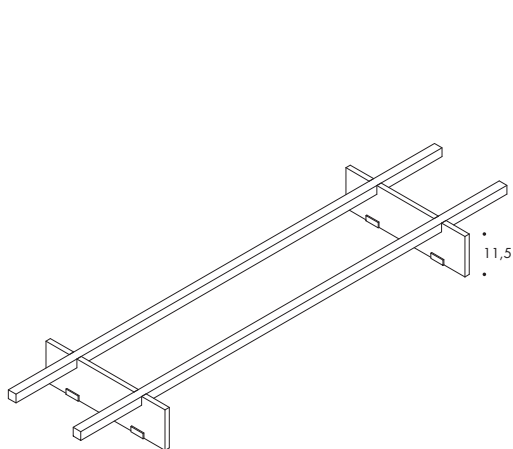

L.	Cod.	m ³	
135	SMMZ0140	0,014	199
180	SMMZ0155	0,016	232
225	SMMZ0170	0,022	255

Madie H. 93,5 P.58 complete di piedini H. 1,7

Sideboards H. 93,5 D.58 with feet H.1,7 included • Bahut H.93,5 P.58 avec verins H.1,7 inclus • Aparadores H.93,5 P.58 con piernas A.1,7 incluydas • Напольный шкаф В.93,5Г.58 включены ножки В1,7

Di serie con apertura PushPull. Con maniglia su frontale + 36 € cad.

Standard with PushPull opening - With handle + 36€ each one
Ouverture standard pousse-lâche - Avec poignée +36 € chaque
De serie con abertura PushPull - Con tirador + 36€ cad.

Стандартное открывание PushPull - С ручкой на фасаде + 36 €/шт.

Scocca - Carcass - Structure - Estructura - Каркас

Basic wood
Basic wood
Basic wood
Basic wood
Basic wood

Frassino-Laccato opaco
Ash wood-Matt lacquered
Frêne-laqué mat
Madera de fresno-lacado mate
Ясень-Лак матовый

Laccato lucido
Gloss lacquered
Laqué brillant
Lacado brillo
Лак глянец

L. 120

L.120 (60+60)

W.120 (60+60) • L.120 (60+60) • L.120 (60+60) • Ш.120 (60+60)

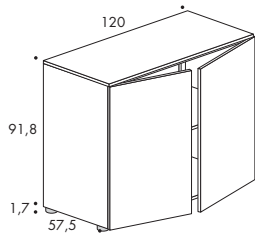

m³ 0,742

Frontale - Front - Façade - Frente - Фасад

	SMAIL	SMMA1210	Basic wood Basic wood • Basic wood • Basic wood • Basic wood	533	596	690
			Frassino-Laccato opaco Ash wood-Matt lacquered • Frêne-laqué mat Madera de fresno-lacado mate • Ясень-Лак матовый	685	748	842
			Laccato lucido Gloss lacquered • Laqué brillant • Lacado brillo • Лак глянец	793	856	950
	LIDO	SMMA2210	Frassino Ash-wood • Frêne • Madera de fresno • Ясень	1.443	1.506	1.600
	SYMPHONIA	SMMA4210	Frassino Ash-wood • Frêne • Madera de fresno • Ясень	1.257	1.320	1.414

L. 180

L.180 (60+60+60)

W.180 (60+60+60) • L.180 (60+60+60) • L.180 (60+60+60) • Ш.180 (60+60+60)

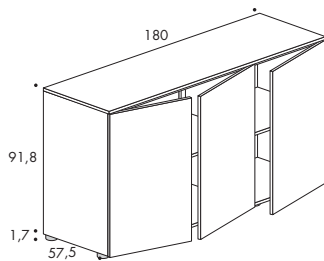

m³ 1,122

Frontale - Front - Façade - Frente - Фасад

	SMAIL	SMMA1230	Basic wood Basic wood • Basic wood • Basic wood • Basic wood	860	988	1.183
			Frassino-Laccato opaco Ash wood-Matt lacquered • Frêne-laqué mat Madera de fresno-lacado mate • Ясень-Лак матовый	1.088	1.216	1.411
			Laccato lucido Gloss lacquered • Laqué brillant • Lacado brillo • Лак глянец	1.250	1.378	1.573
	LIDO	SMMA2230	Frassino Ash-wood • Frêne • Madera de fresno • Ясень	2.225	2.353	2.548
	SYMPHONIA	SMMA4230	Frassino Ash-wood • Frêne • Madera de fresno • Ясень	1.946	2.074	2.269

Madie H. 93,5 P.58 complete di piedini H. 1,7

Sideboards H. 93,5 D.58 with feet H.1,7 included • Bahut H.93,5 P.58 avec verins H.1,7 inclus • Aparadores H.93,5 P.58 con piernas A.1,7 incluydas • Напольный шкаф В.93,5 Г.58 включены ножки В1,7

Di serie con apertura PushPull. Con maniglia su frontale + 36 € cad.

Standard with PushPull opening - With handle + 36€ each one

Ouverture standard pousse-lâche - Avec poignée +36 € chaque

De serie con abertura PushPull - Con tirador + 36€ cad.

Стандартное открывание PushPull - С ручкой на фасаде + 36 €/шт.

Scocca - Carcass - Structure - Estructura - Каркас

Basic wood
Basic wood
Basic wood
Basic wood
Basic wood

Frassino-Laccato opaco
Ash wood-Matt lacquered
Frêne-laqué mat
Madera de fresno-lacado mate
Ясень-Лак матовый

Laccato lucido
Gloss lacquered
Laqué brillant
Lacado brillo
Лак глянец

L. 240

L.240 (60+60+60+60)

W.240 (60+60+60+60) • L.240 (60+60+60+60) • L.240 (60+60+60+60) • Ш.240 (60+60+60+60)

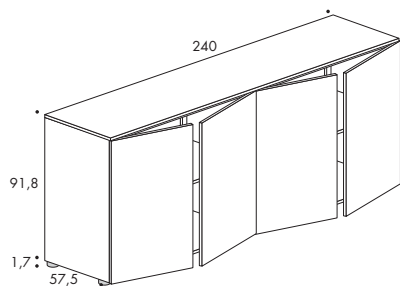

m³ 1,484

Frontale - Front - Façade - Frente - Фасад

	SMAIL	SMMA1260	Basic wood Basic wood • Basic wood • Basic wood • Basic wood	1.033	1.158	1.346
			Frassino-Laccato opaco Ash wood-Matt lacquered • Frêne-laqué mat Madera de fresno-lacado mate • Ясень-Лак матовый	1.337	1.462	1.650
			Laccato lucido Gloss lacquered • Laqué brillant • Lacado brillo • Лак глянец	1.553	1.678	1.866
	LIDO	SMMA2260	Frassino Ash-wood • Frêne • Madera de fresno • Ясень	2.853	2.978	3.166
	SYMPHONIA	SMMA4260	Frassino Ash-wood • Frêne • Madera de fresno • Ясень	2.481	2.606	2.794

Zoccoli alluminio (OPTIONAL)

Aluminium socle (optional)

Socle aluminium (optionnelle)

Patas de aluminio (opcional)

Аллюминиевый цоколь (Опция)

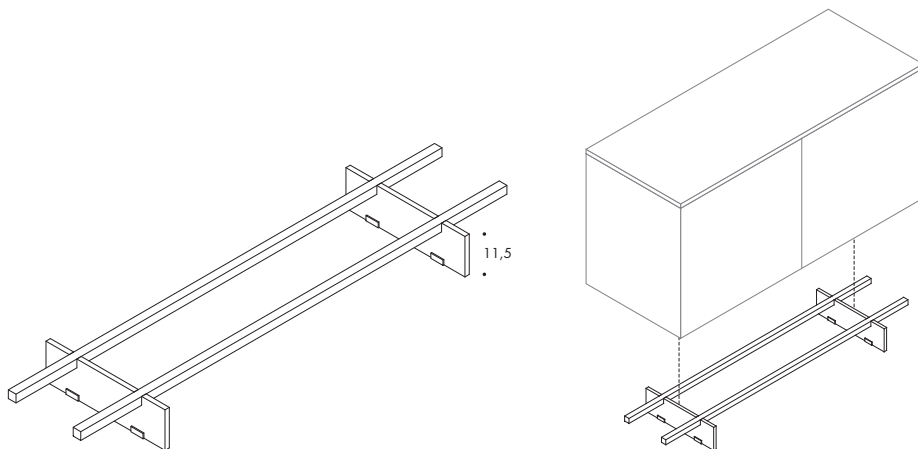

L.	Cod.	m ³	
120	SMMZ0135	0,013	190
180	SMMZ0155	0,016	232
240	SMMZ0175	0,022	264

Madie H. 93,5 P.58 complete di piedini H. 1,7

Sideboards H. 93,5 D.58 with feet H.1,7 included • Bahut H.93,5 P.58 avec verins H.1,7 inclus • Aparadores H.93,5 P.58 con piernas A.1,7 incluydas • Напольный шкаф В.93,5 Г.58 включены ножки В1,7

Di serie con apertura PushPull. Con maniglia su frontale + 36 € cad.

Standard with PushPull opening - With handle + 36€ each one
Ouverture standard pousse-lâche - Avec poignée +36 € chaque
De serie con abertura PushPull - Con tirador + 36€ cad.

Стандартное открывание PushPull - С ручкой на фасаде + 36 €/шт.

Scocca - Carcass - Structure - Estructura - Каркас

Basic wood
Basic wood
Basic wood
Basic wood

Frassino-Laccato opaco
Ash wood-Matt lacquered
Frêne-laqué mat
Madera de fresno-lacado mate
Ясень-Лак матовый

Laccato lucido
Gloss lacquered
Laqué brillant
Lacado brillo
Лак глянец

L. 120

L.120 (60+60)

W.120 (60+60) • L.120 (60+60) • L.120 (60+60) • Ш.120 (60+60)

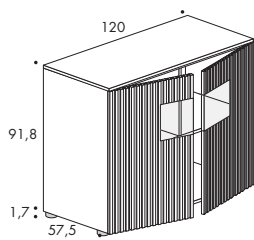

m³ 0,742

Frontale - Front - Façade - Frente - Фасад

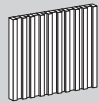

SYMPHONIA

SMMA5210

Frassino
Ash-wood • Frêne • Madera de fresno • Ясень

1.323

1.386

1.480

LUCE OPTIONAL

Optional light • Eclairage optionelle
Luz opcional • Подсветка опция

SMCV1000

m³ 0,001

160

L. 180

L.180 (45+45+45+45)

W.180 (45+45+45+45) • L.180 (45+45+45+45) • L.180 (45+45+45+45) • Ш.180 (45+45+45+45)

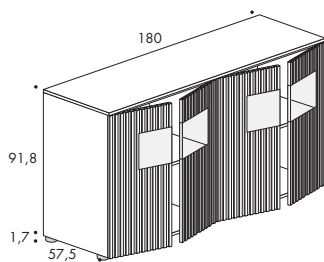

m³ 1,122

Frontale - Front - Façade - Frente - Фасад

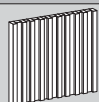

SYMPHONIA

SMMA5240

Frassino
Ash-wood • Frêne • Madera de fresno • Ясень

2.186

2.314

2.544

LUCE OPTIONAL

Optional light • Eclairage optionelle
Luz opcional • Подсветка опция

SMCV1000

m³ 0,001

160

Madie H. 93,5 P.58 complete di piedini H. 1,7

Sideboards H. 93,5 D.58 with feet H.1,7 included • Bahut H.93,5 P.58 avec verins H.1,7 inclus • Aparadores H.93,5 P.58 con piernas A.1,7 incluydas • Напольный шкаф В.93,5 Г.58 включены ножки В1,7

Di serie con apertura PushPull. Con maniglia su frontale + 36 € cad.

Standard with PushPull opening - With handle + 36€ each one

Ouverture standard pousse-lâche - Avec poignée +36 € chaque

De serie con abertura PushPull - Con tirador + 36€ cad.

Стандартное открывание PushPull - С ручкой на фасаде + 36 €/шт.

Scocca - Carcass - Structure - Estructura - Каркас

Basic wood
Basic wood
Basic wood
Basic wood
Basic wood

Frassino-Laccato opaco
Ash wood-Matt lacquered
Frêne-laqué mat
Madera de fresno-lacado mate
Ясень-Лак матовый

Laccato lucido
Gloss lacquered
Laqué brillant
Lacado brillo
Лак глянец

L. 240

L.240 (60+60+60+60)

W.240 (60+60+60+60) • L.240 (60+60+60+60) • L.240 (60+60+60+60) • Ш.240 (60+60+60+60)

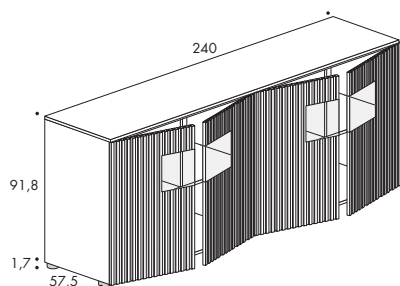

m³ 1,484

Frontale - Front - Façade - Frente - Фасад

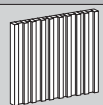

SYMPHONIA

SMA5260

Frassino
Ash-wood • Frêne • Madera de fresno • Ясень

2.613

2.738

2.926

LUCE OPTIONAL

Optional light • Eclairage optionelle
Luz opcional • Подсветка опция

SMCV1000

m³ 0,001

160

Zoccoli alluminio (OPTIONAL)

Aluminium socle (optional)

Socle aluminium (optionelle)

Patas de aluminio (opcional)

Аллюминиевый цоколь (Опция)

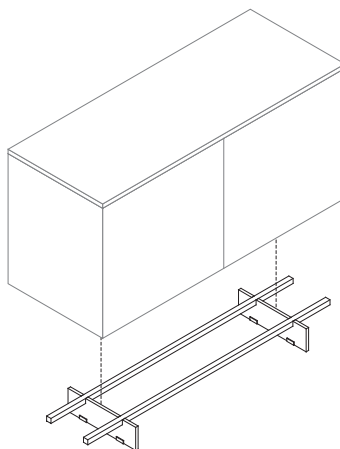
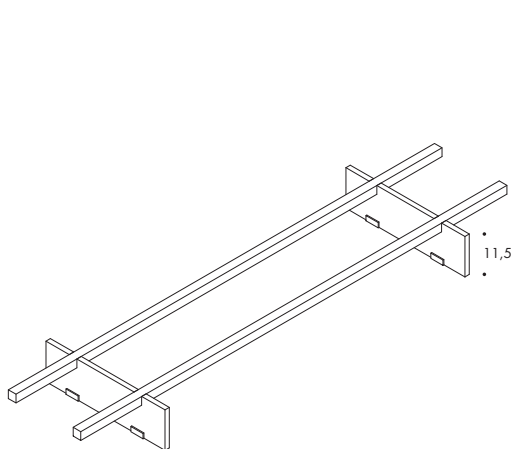

L.	Cod.	m ³	
120	SMMZ0135	0,013	190
180	SMMZ0155	0,016	232
240	SMMZ0175	0,022	264